

# Mizu, flowing *light*.

design Nicolas Terzani  
terzani.com



**Product Name**  
Mizu  
pendant light

**Materials**  
clear crystal

### Finishes | Code

-  white disc/clear  
OR01S E8 A9. KK
-  white disc/clear/silver dust  
OR01S E8 F4. KK
-  white disc/clear/gold  
OR01S E8 A4. KK
-  white disc/clear/champagne  
OR01S E8 H1. KK
-  white disc/clear/cognac  
OR01S E8 H4. KK

**Body**

NO DRIVER INCLUDED

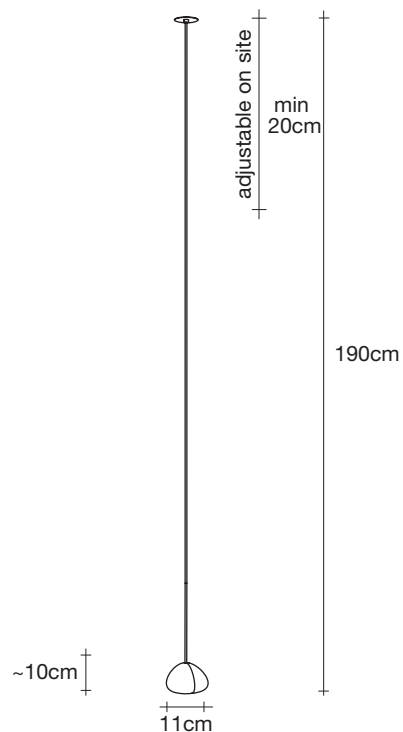

### Recommended Light

12V ~ 50/60Hz

 HALOGEN  
10W G4 12V

or

 LED  
2W G4 12V

500mA ~ 50/60Hz

 LED integrated  
1,5W 180 lm 3000K  
or optional 2700K

dimnable drivers available

 IGTB  
100K Ω  
0/1-10V  
PUSH  
DALI system

**Disc**

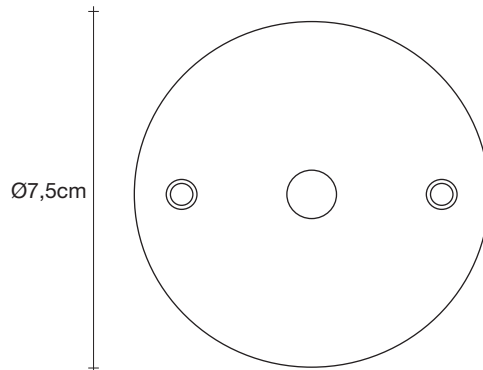
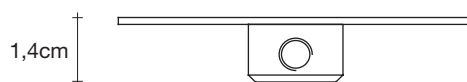

Inspired by the tranquil and mesmerizing light refractions created by water, Mizu is a customizable pendant light from Terzani. Like water droplets, no two Mizu are alike, each crystal shape is unique and made meticulously by hand. Using only the clearest crystal, Mizu perfectly emulates water's refraction of light, casting amazing patterns around the room, reminiscent of flowing water. Also available in gold leaf. Design Nicolas Terzani

# Mizu, flowing *light*.

design Nicolas Terzani  
terzani.com

**TERZANI**  
LA LUCE PENSATA



**Product Name**  
Mizu  
pendant light

**Materials**  
clear crystal



### Finishes | Code

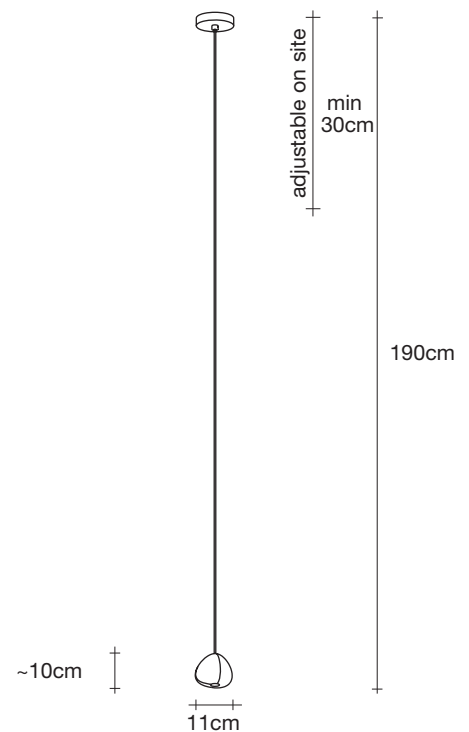

-  clear  
OR01S H4 A9.
-  clear/silver dust  
OR01S H4 F4.
-  clear/gold  
OR01S E8 A4.
-  clear/champagne  
OR01S E8 H1.
-  clear/cognac  
OR01S E8 H4.

### Body



### Recommended Light

230-240V ~ 50/60Hz

-  HALOGEN  
10W G4 12V
- or
-  LED  
2W G4 12V  
3W G4 12V
- or
-  LED integrated  
1,5W 180 lm 3000K  
or optional 2700K

**dimnable with**

-  IGBT  
TRIAC  
DALI system

Inspired by the tranquil and mesmerizing light refractions created by water, Mizu is a customizable pendant light from Terzani. Like water droplets, no two Mizu are alike, each crystal shape is unique and made meticulously by hand. Using only the clearest crystal, Mizu perfectly emulates water's refraction of light, casting amazing patterns around the room, reminiscent of flowing water. Also available in gold leaf. Design Nicolas Terzani

### Canopy | white or brushed nickel

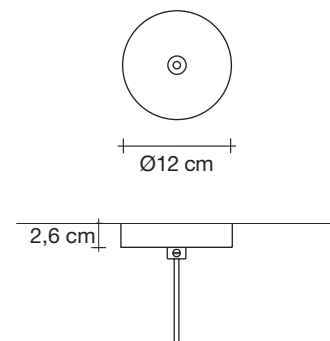

### Canopy for DALI

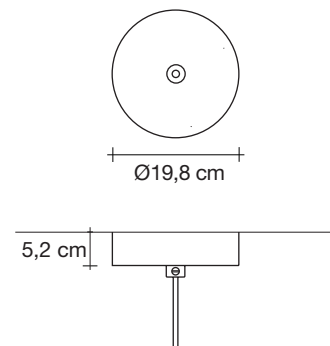

# Mizu, flowing *light*.

design Nicolas Terzani  
terzani.com

**TERZANI**  
LA LUCE PENSATA



## Product Name

Mizu  
3 light pendant

## Materials

clear crystal



## Finishes | Code

-  clear  
OR03S H4 A9.
-  clear/silver dust  
OR03S H4 F4.
-  clear/gold  
OR03S E8 A4.
-  clear/champagne  
OR03S E8 H1.
-  clear/cognac  
OR03S E8 H4.

## Body

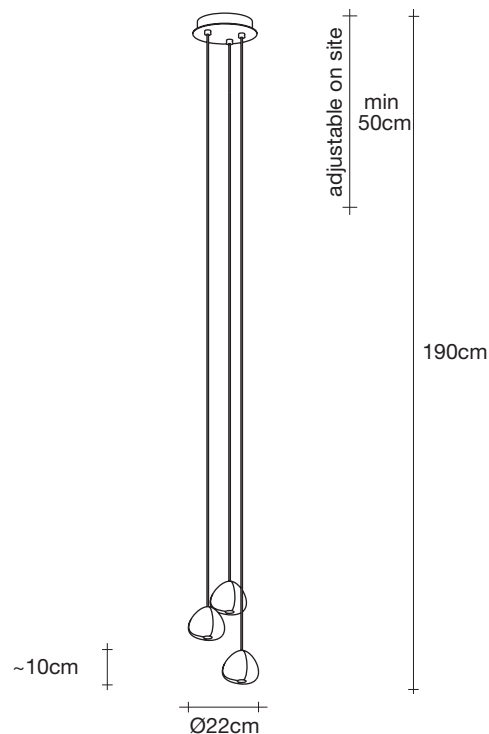

## Recommended Light

230-240V ~ 50/60Hz

 HALOGEN  
3 x 10W G4 12V

or

 LED  
3 x 2W G4 12V

or

 LED integrated  
3 x 1,5W 540 lm 3000K  
or optional 2700K

**dimnable with**

 IGBT  
1-10V  
PUSH  
DALI system

## Canopy | white or brushed nickel

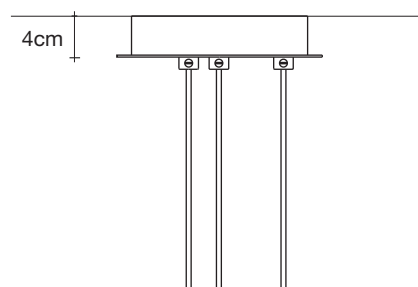
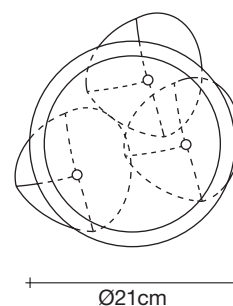

Inspired by the tranquil and mesmerizing light refractions created by water, Mizu is a customizable pendant light from Terzani. Like water droplets, no two Mizu are alike, each crystal shape is unique and made meticulously by hand. Using only the clearest crystal, Mizu perfectly emulates water's refraction of light, casting amazing patterns around the room, reminiscent of flowing water. Also available in gold leaf. Design Nicolas Terzani

# Mizu, flowing *light*.

design Nicolas Terzani  
terzani.com

**TERZANI**  
LA LUCE PENSATA



**Product Name**  
Mizu  
5 light pendant

**Materials**  
clear crystal



### Finishes | Code

-  clear  
OR05S H4 A9.
-  clear/silver dust  
OR05S H4 F4.
-  clear/gold  
OR05S E8 A4.
-  clear/champagne  
OR05S E8 H1.
-  clear/cognac  
OR05S E8 H4.

### Body

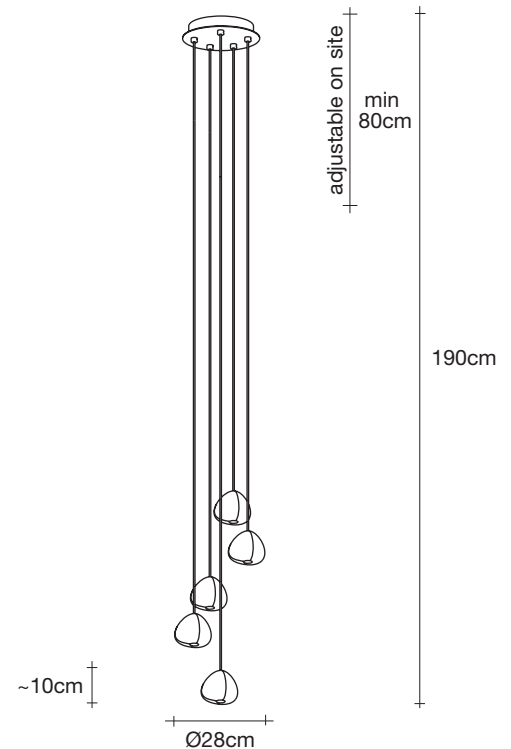

### Recommended Light

230-240V ~ 50/60Hz

 HALOGEN  
5 x 10W G4 12V

or

 LED  
5 x 2W G4 12V

or

 LED integrated  
5 x 1,5W 900 lm 3000K  
or optional 2700K

**dimnable with**

 IGBT  
0/1-10V  
10V PWM  
PUSH  
DALI system

### Canopy | white or brushed nickel

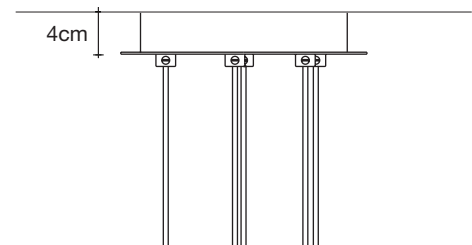
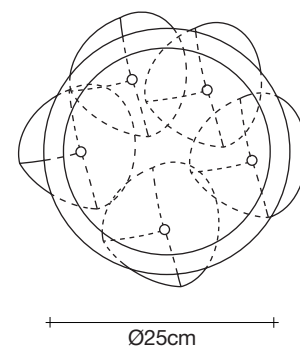

Inspired by the tranquil and mesmerizing light refractions created by water, Mizu is a customizable pendant light from Terzani. Like water droplets, no two Mizu are alike, each crystal shape is unique and made meticulously by hand. Using only the clearest crystal, Mizu perfectly emulates water's refraction of light, casting amazing patterns around the room, reminiscent of flowing water. Also available in gold leaf. Design Nicolas Terzani

# Mizu, flowing *light*.

design Nicolas Terzani  
terzani.com

**TERZANI**  
LA LUCE PENSATA



## Product Name



Mizu  
7 light pendant

## Materials

clear crystal



## Finishes | Code

-  clear  
OR07S H4 A9.
-  clear/silver dust  
OR07S H4 F4.
-  clear/gold  
OR07S E8 A4.
-  clear/champagne  
OR07S E8 H1.
-  clear/cognac  
OR07S E8 H4.

## Body

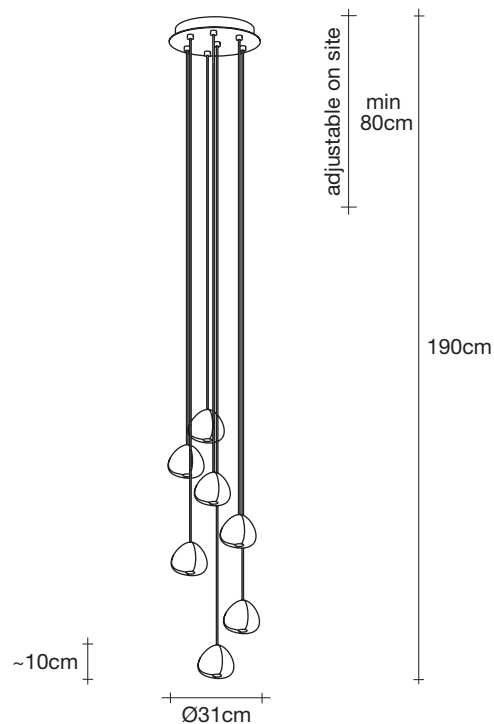

## Recommended Light

230-240V ~ 50/60Hz



HALOGEN  
7 x 10W G4 12V

or



LED  
7 x 2W G4 12V

or



LED integrated  
7 x 1,5W 1260 lm 3000K  
or optional 2700K

**dimnable with**



IGBT  
0/1-10V  
PWM  
PUSH  
DALI system

## Canopy | white or brushed nickel

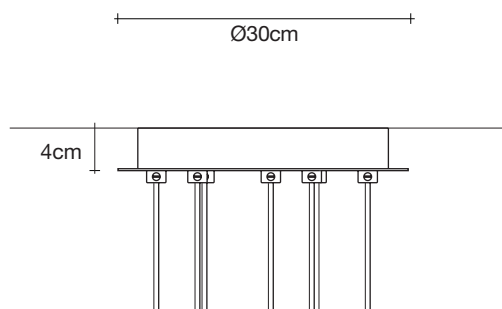
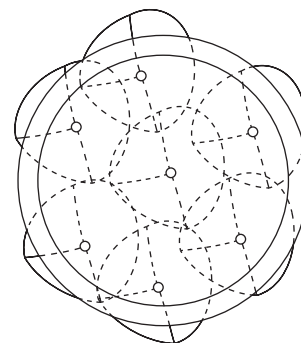

Inspired by the tranquil and mesmerizing light refractions created by water, Mizu is a customizable pendant light from Terzani. Like water droplets, no two Mizu are alike, each crystal shape is unique and made meticulously by hand. Using only the clearest crystal, Mizu perfectly emulates water's refraction of light, casting amazing patterns around the room, reminiscent of flowing water. Also available in gold leaf. Design Nicolas Terzani



# Mizu, flowing *light*.

design Nicolas Terzani  
terzani.com

**TERZANI**  
LA LUCE PENSATA



## Product Name





Mizu  
15 rectangular multi light pendant

## Materials

clear crystal



## Finishes | Code

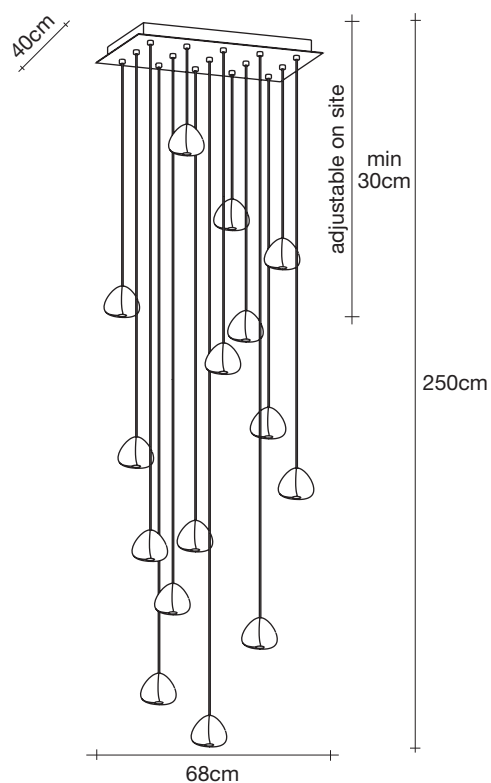

-  clear  
OR15S E8 A9. R
-  clear/silver dust  
OR15S E8 F4. R
-  clear/gold  
OR15S E8 A4. R
-  clear/champagne  
OR15S E8 H1. R
-  clear/cognac  
OR15S E8 H4. R

## Body



## Recommended Light

230-240V ~ 50/60Hz

-  HALOGEN  
15 x 10W G4 12V
- or
-  LED  
15 x 2W G4 12V
- or
-  LED integrated  
15 x 1,5W 2700 lm 3000K  
or optional 2700K

**dimnable with**

-  IGBT  
0/1-10V  
PWM  
PUSH  
DALI system

## Canopy | white

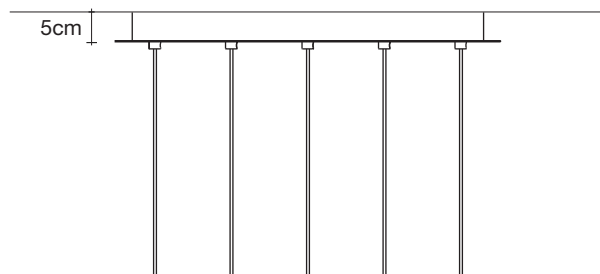
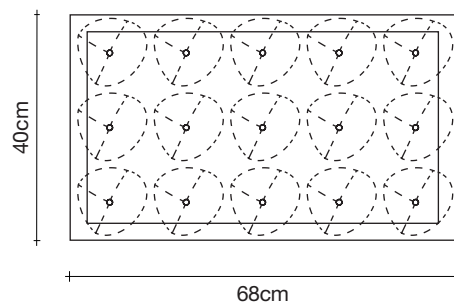

Inspired by the tranquil and mesmerizing light refractions created by water, Mizu is a customizable pendant light from Terzani. Like water droplets, no two Mizu are alike, each crystal shape is unique and made meticulously by hand. Using only the clearest crystal, Mizu perfectly emulates water's refraction of light, casting amazing patterns around the room, reminiscent of flowing water. Also available in gold leaf. Design Nicolas Terzani

# Mizu, flowing *light.*

design Nicolas Terzani  
terzani.com

**TERZANI**  
LA LUCE PENSATA



## Product Name

Mizu  
15 round multi light pendant

## Materials

clear crystal



## Finishes | Code

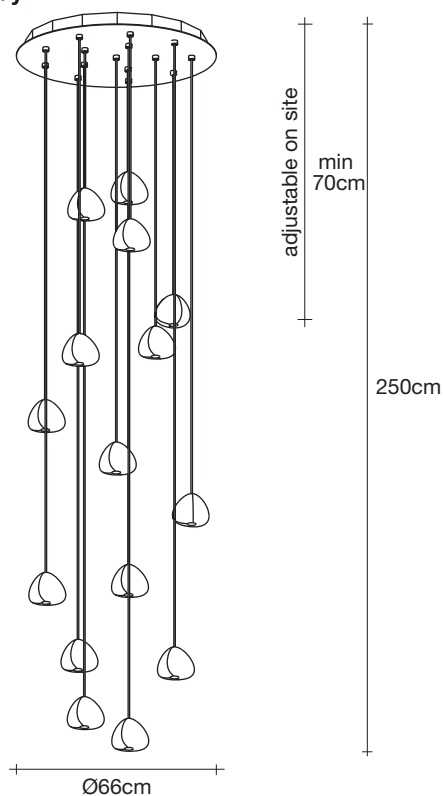

-  clear  
OR15S E8 A9. T
-  clear/silver dust  
OR15S E8 F4. T
-  clear/gold  
OR15S E8 A4. T
-  clear/champagne  
OR15S E8 H1. T
-  clear/cognac  
OR15S E8 H4. T

## Body



## Recommended Light

230-240V ~ 50/60Hz

-  HALOGEN  
15 x 10W G4 12V
- or
-  LED  
15 x 2W G4 12V
- or
-  LED integrated  
15 x 1,5W 2700 lm 3000K  
or optional 2700K

**dimnable with**

-  IGBT  
0/1-10V  
PWM  
PUSH  
DALI system

## Canopy | white

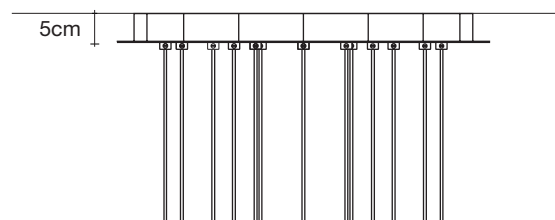
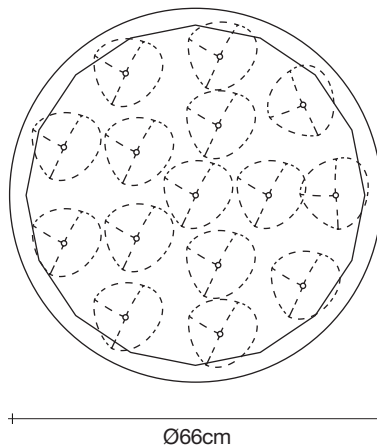

# Mizu, flowing *light*.

design Nicolas Terzani  
terzani.com

**TERZANI**  
LA LUCE PENSATA







**Product Name**  
Mizu  
26 square multi light pendant

**Materials**  
clear crystal



### Finishes | Code

-  clear  
OR26S E8 A9. Q
-  clear/silver dust  
OR26S E8 F4. Q
-  clear/gold  
OR26S E8 A4. Q
-  clear/champagne  
OR26S E8 H1. Q
-  clear/cognac  
OR26S E8 H4. Q

### Body

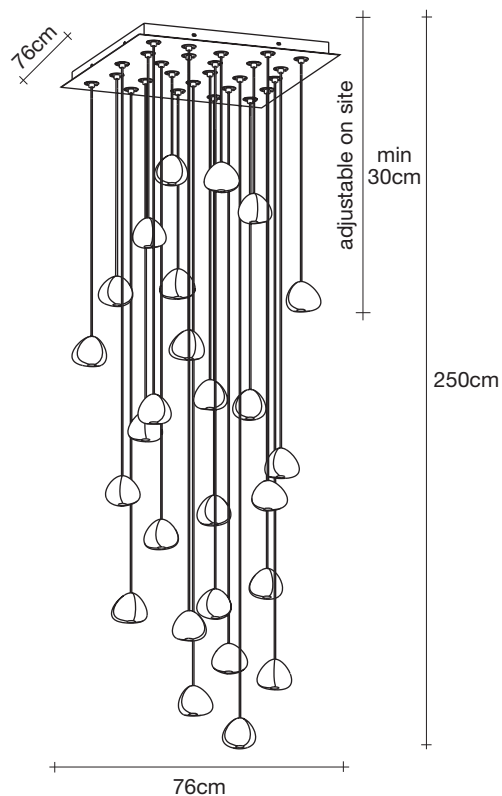

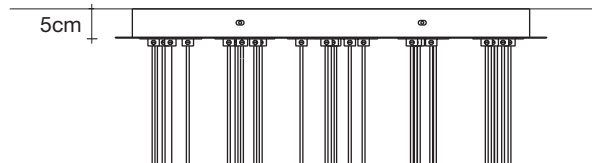
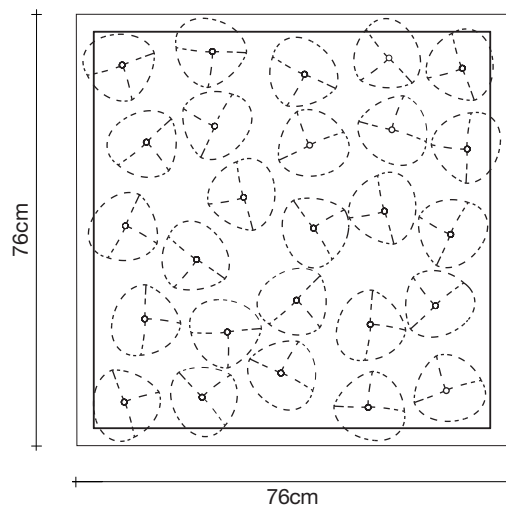

### Canopy | white - quick system



### Recommended Light

230-240V ~ 50/60Hz

-  HALOGEN  
26 x 10W G4 12V
- or
-  LED  
26 x 2W G4 12V
- or
-  LED integrated  
26 x 1,5W 4680 lm 3000K  
or optional 2700K

**dimmable with**

-  IGBT  
0/1-10V  
PWM  
PUSH  
DALI system

Inspired by the tranquil and mesmerizing light refractions created by water, Mizu is a customizable pendant light from Terzani. Like water droplets, no two Mizu are alike, each crystal shape is unique and made meticulously by hand. Using only the clearest crystal, Mizu perfectly emulates water's refraction of light, casting amazing patterns around the room, reminiscent of flowing water. Also available in gold leaf. Design Nicolas Terzani



# Mizu, flowing *light*.

design Nicolas Terzani  
terzani.com





**Product Name**  
Mizu  
26 round multi light pendant

**Materials**  
clear crystal



**Finishes | Code**

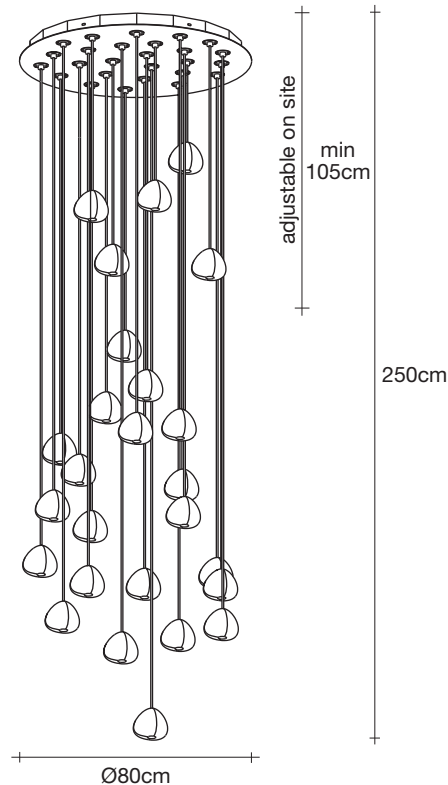

-  clear  
OR26S E8 A9. T
-  clear/silver dust  
OR26S E8 F4. T
-  clear/gold  
OR26S E8 A4. T
-  clear/champagne  
OR26S E8 H1. T
-  clear/cognac  
OR26S E8 H4. T

**Body**



**Recommended Light**

230-240V ~ 50/60Hz

-  HALOGEN  
26 x 10W G4 12V
- or
-  LED  
26 x 2W G4 12V
- or
-  LED integrated  
26 x 1,5W 4680 lm 3000K  
or optional 2700K

**dimmable with**

-  IGBT  
0/1-10V  
PWM  
PUSH  
DALI system

**Canopy | white - quick system**

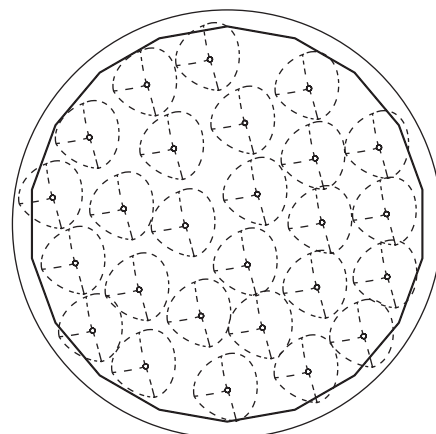

Ø80cm

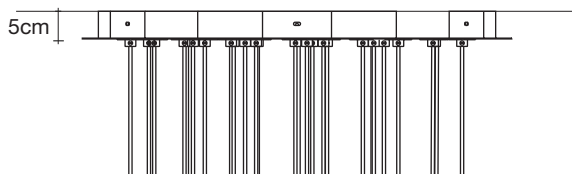

Inspired by the tranquil and mesmerizing light refractions created by water, Mizu is a customizable pendant light from Terzani. Like water droplets, no two Mizu are alike, each crystal shape is unique and made meticulously by hand. Using only the clearest crystal, Mizu perfectly emulates water's refraction of light, casting amazing patterns around the room, reminiscent of flowing water. Also available in gold leaf. Design Nicolas Terzani