

Argent, a Precious, *Cloud.*

design Dodo Arslan
terzani.com



Type |
Suspension

Materials |
Stainless steel

Finishes | Code



White disc/Stainless Steel
ON90S E7 C8 KK



White disc/Gold plated
ON90S L6 C8 KK



White disc/Rose Gold
ON90S N4 C8 KK

or on request



White disc/Champagne



White disc/Black nickel

Body |

NO DRIVER INCLUDED

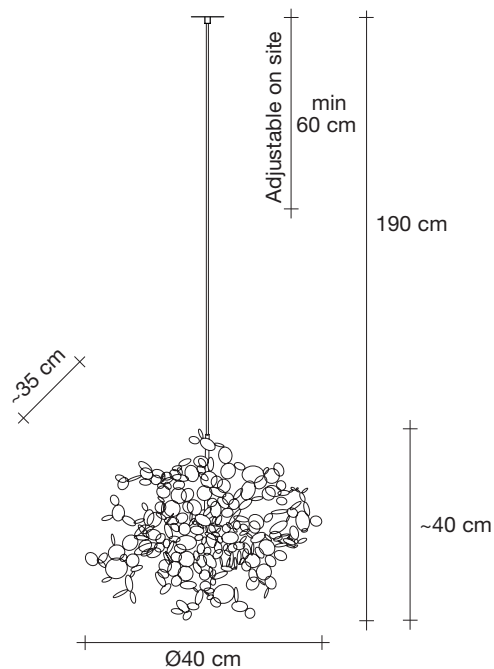

Recommended light | Disc |

12V ~ 50/60Hz



HALOGEN
3 x 20W G4 12V

or



LED
3 x 2W G4 12V

dimnable drivers available



IGBT
DALI system

1,4 cm



Ø7,5 cm

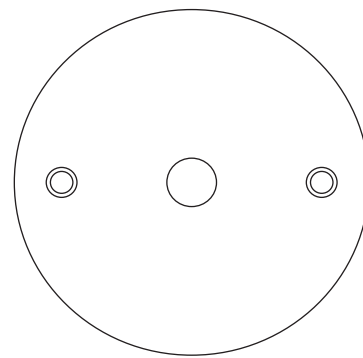

With this new suspension light, designer Dodo Arslan creates a shimmering, silver cloud. Argent consists of metal discs that have been meticulously joined by hand by Terzani craftsmen into clusters. Once lit, the multiple, angled surfaces of the discs emanate a soft, shimmering glow. Design Dodo Arslan.

Argent, a Precious, *Cloud.*

design Dodo Arslan
terzani.com

TERZANI
LA LUCE PENSATA



Type |
Suspension

Materials |
Stainless steel

Finishes | Code

 Stainless Steel
0N90S E7 C8

 Gold plated
0N90S L6 C8

 Rose Gold
0N90S N4 C8

or on request

 Champagne

 Black nickel

Body |

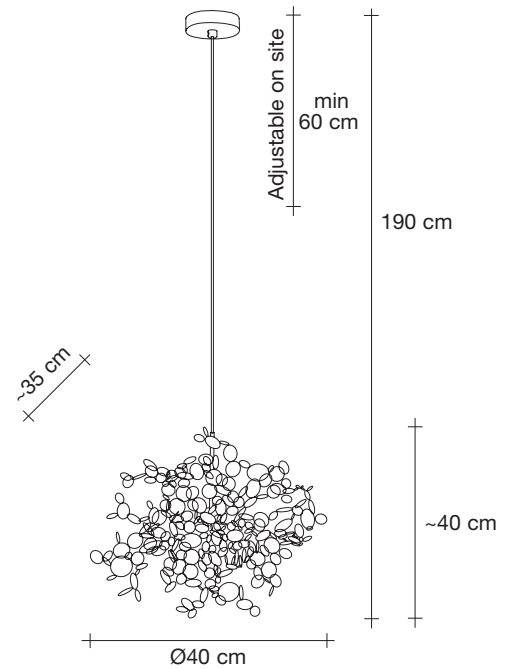

Recommended Light | Canopy |

230-240V ~ 50/60Hz

 HALOGEN
3 x 20W G4 12V

or

 LED
3 x 2W G4 12V

dimmable with

 IGBT
TRIAC
DALI system

Canopy for DALI |

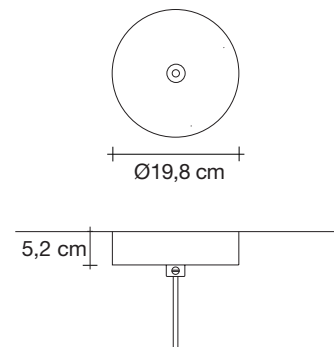
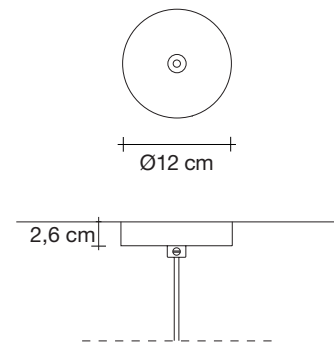

With this new suspension light, designer Dodo Arslan creates a shimmering, silver cloud. Argent consists of metal discs that have been meticulously joined by hand by Terzani craftsmen into clusters. Once lit, the multiple, angled surfaces of the discs emanate a soft, shimmering glow. Design Dodo Arslan.

Argent, a Precious, *Cloud.*

design Dodo Arslan
terzani.com

TERZANI
LA LUCE PENSATA



Type |
Suspension

Materials |
Stainless steel

Finishes | Code

 Stainless Steel
0N91S E7 C8

 Gold plated
0N91S L6 C8

 Rose Gold
0N91S N4 C8

or on request

 Champagne

 Black nickel

Body |

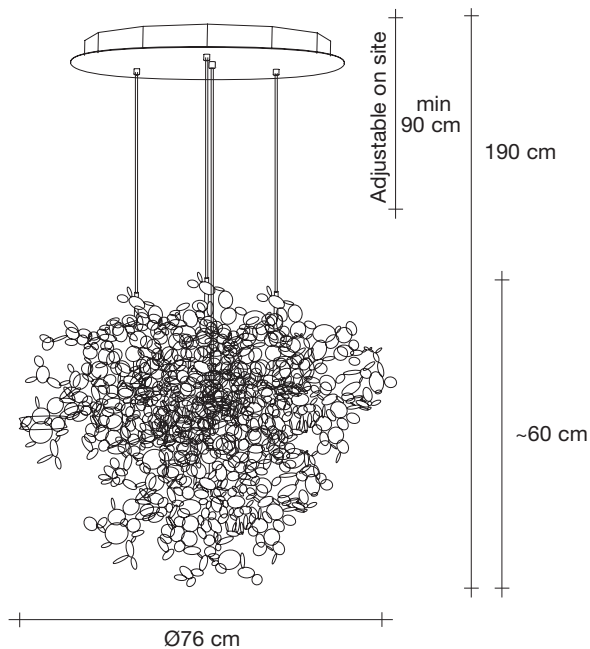

Recommended Light |

230-240V ~ 50/60Hz

 HALOGEN
12 x 20W G4 12V

or

 LED
12 x 2W G4 12V

dimmable with

 IGBT
1-10V
10V PWM
DALI system

Canopy | White canopy

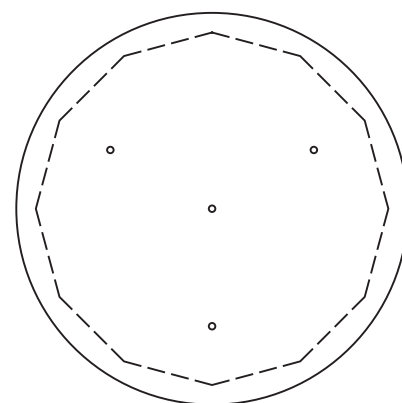
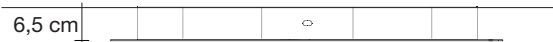

With this new suspension light, designer Dodo Arslan creates a shimmering, silver cloud. Argent consists of metal discs that have been meticulously joined by hand by Terzani craftsmen into clusters. Once lit, the multiple, angled surfaces of the discs emanate a soft, shimmering glow. Design Dodo Arslan.

Argent, a Precious, *Cloud.*

design Dodo Arslan
terzani.com

TERZANI
LA LUCE PENSATA



Type |
Suspension

Materials |
Stainless steel

Finishes | Code

 Stainless Steel
0N92S E7 C8

 Gold plated
0N92S L6 C8

 Rose Gold
0N92S N4 C8

or on request

 Champagne

 Black nickel

Body |

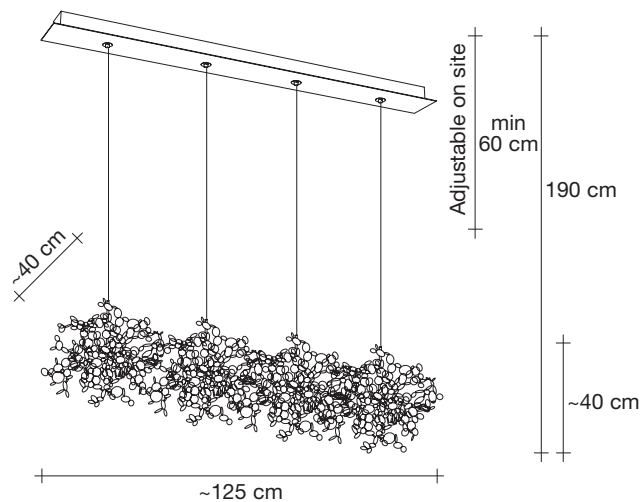

Recommended Light | Canopy | White canopy

230-240V ~ 50/60Hz

 HALOGEN
12 x 20W G4 12V

or

 LED
12 x 2W G4 12V

dimmable with

 IGBT
1-10V
10V PWM
DALI system

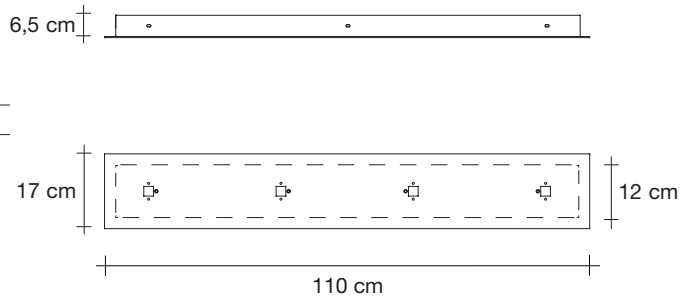

With this new suspension light, designer Dodo Arslan creates a shimmering, silver cloud. Argent consists of metal discs that have been meticulously joined by hand by Terzani craftsmen into clusters. Once lit, the multiple, angled surfaces of the discs emanate a soft, shimmering glow. Design Dodo Arslan.

Argent, a Precious, *Cloud.*

design Dodo Arslan
terzani.com

TERZANI
LA LUCE PENSATA



Type |
Suspension

Materials |
Stainless steel

Finishes | Code

 Stainless Steel
0N89S E7 C8

 Gold plated
0N89S L6 C8

 Rose Gold
0N89S N4 C8

or on request

 Champagne

 Black nickel

Body |

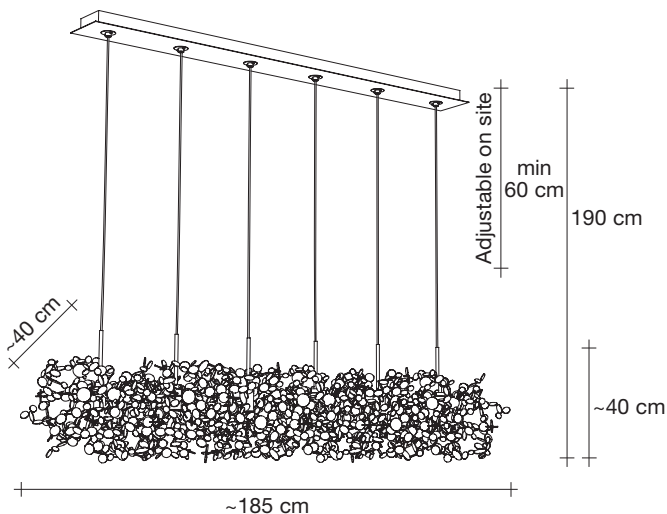

Recommended Light | Canopy | White canopy

230-240V ~ 50/60Hz

 HALOGEN
18 x 20W G4 12V

or

 LED
18 x 2W G4 12V

dimmable with

 IGBT
1-10V
10V PWM
DALI system

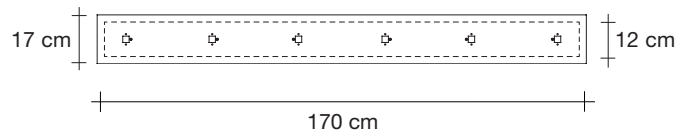
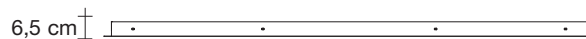

With this new suspension light, designer Dodo Arslan creates a shimmering, silver cloud. Argent consists of metal discs that have been meticulously joined by hand by Terzani craftsmen into clusters. Once lit, the multiple, angled surfaces of the discs emanate a soft, shimmering glow. Design Dodo Arslan.

Argent, a Precious, *Cloud.*

design Dodo Arslan
terzani.com

TERZANI
LA LUCE PENSATA



Type |
Suspension

Materials |
Stainless steel

Finishes | Code

 Stainless Steel
ON95S E7 C8

 Gold plated
ON95S L6 C8

 Rose Gold
ON95S N4 C8

or on request

 Champagne

 Black nickel

Body |

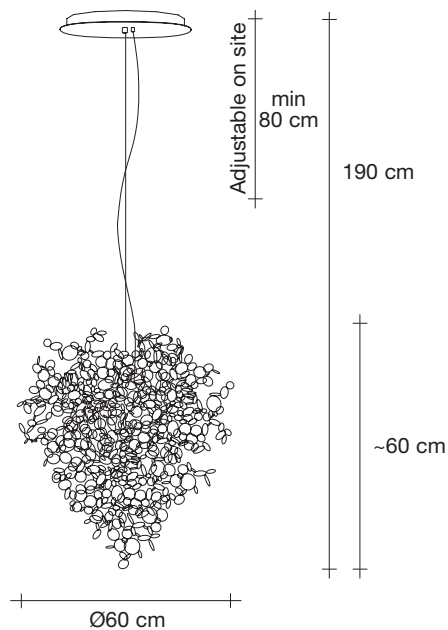

Integrated Led |
230-240V ~ 50/60Hz

 LED integrated
6 x 2,1W 1640 lm
3000K or 2700K

dimmable with

 1-10V
0/1-10V
PUSH
DALI system

Canopy | Nickel or White canopy

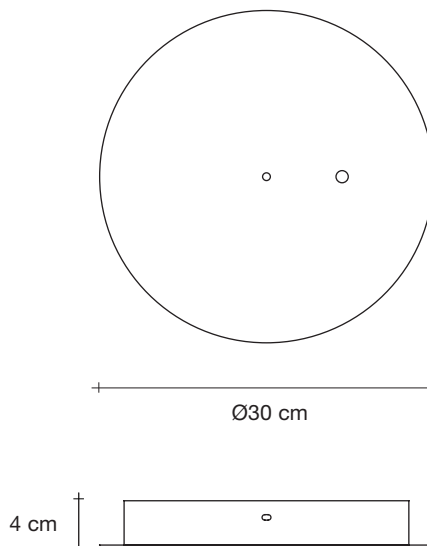

With this new suspension light, designer Dodo Arslan creates a shimmering, silver cloud. Argent consists of metal discs that have been meticulously joined by hand by Terzani craftsmen into clusters. Once lit, the multiple, angled surfaces of the discs emanate a soft, shimmering glow. Design Dodo Arslan.

Argent, a Precious, *Cloud.*

design Dodo Arslan
terzani.com

TERZANI
LA LUCE PENSATA





Type |
Suspension

Materials |
Stainless steel

Finishes | Code

 Stainless Steel
ON93S E7 C8

 Gold plated
ON93S L6 C8

 Rose Gold
ON93S N4 C8

or on request

 Champagne

 Black nickel

Body |

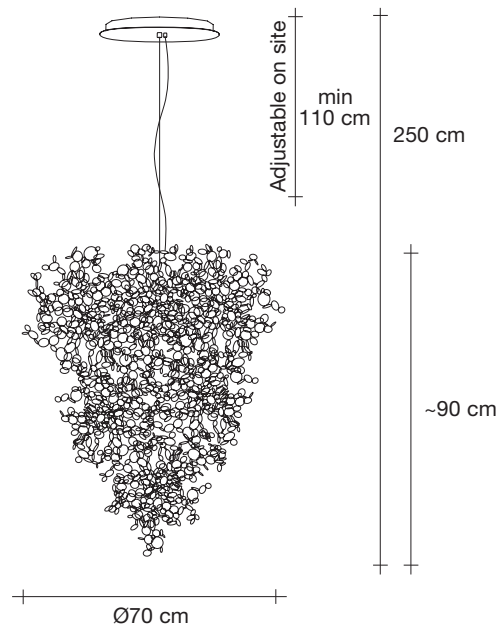

Canopy | Nickel or White canopy

Integrated Led |
230-240V ~ 50/60Hz

 LED integrated
12 x 2,1W 3285 lm
3000K or 2700K

dimmable with

 1-10V
PUSH
DALI system

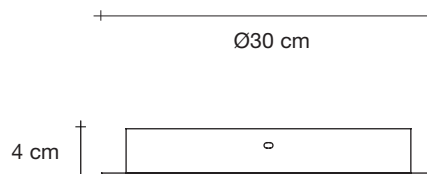
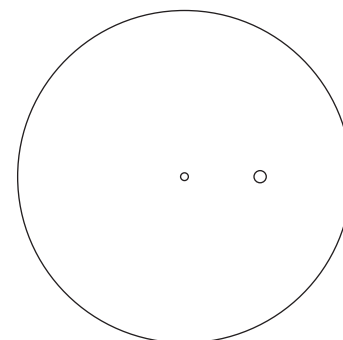

With this new suspension light, designer Dodo Arslan creates a shimmering, silver cloud. Argent consists of metal discs that have been meticulously joined by hand by Terzani craftsmen into clusters. Once lit, the multiple, angled surfaces of the discs emanate a soft, shimmering glow. Design Dodo Arslan.

Argent, a Precious, *Cloud.*

design Dodo Arslan
terzani.com

TERZANI
LA LUCE PENSATA



Type |
Suspension

Materials |
Stainless steel

Finishes | Code

 Stainless Steel
ON94S E7 C8

 Gold plated
ON94S L6 C8

 Rose Gold
ON94S N4 C8

or on request

 Champagne

 Black nickel

Body |

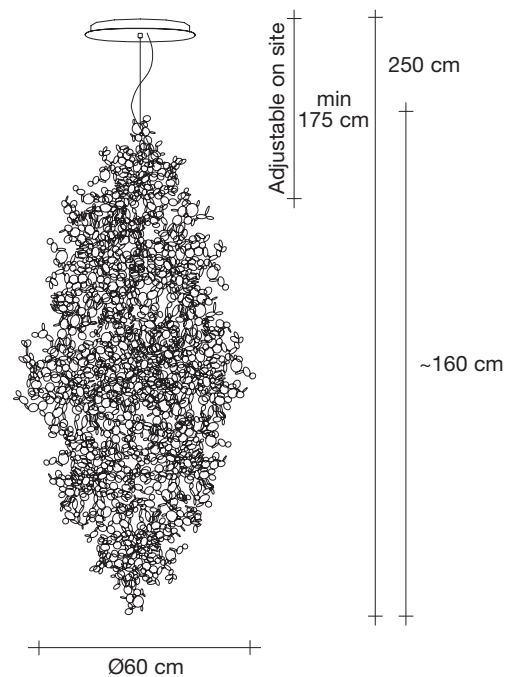

Integrated Led |
230-240V ~ 50/60Hz

 LED integrated
18 x 2,1W 4930 lm
3000K or 2700K

dimmable with

 PUSH
DALI system

Canopy | Nickel or White canopy

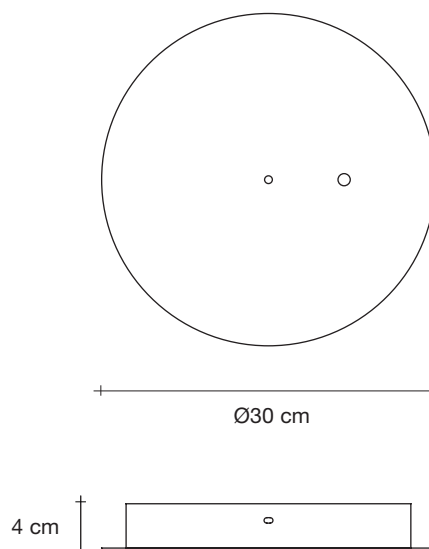

With this new suspension light, designer Dodo Arslan creates a shimmering, silver cloud. Argent consists of metal discs that have been meticulously joined by hand by Terzani craftsmen into clusters. Once lit, the multiple, angled surfaces of the discs emanate a soft, shimmering glow. Design Dodo Arslan.

Argent, a Precious, *Cloud.*

design Dodo Arslan
terzani.com

TERZANI
LA LUCE PENSATA



Type |
Ceiling lamp

Materials |
Stainless steel

Finishes | Code

 Stainless Steel
ON99L E7 C8

 Gold plated
ON99L L6 C8

 Rose Gold
ON99L N4 C8

or on request

 Champagne

 Black nickel

Body |

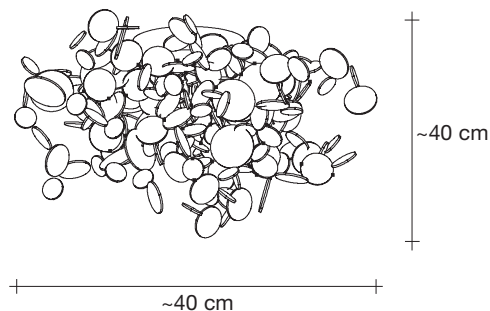

Recommended Light | Canopy |

230-240V ~ 50/60Hz

 HALOGEN
3 x 20W G4 12V

or

 LED
3 x 2W G4 12V

dimmable with

 IGBT
TRIAC
DALI system

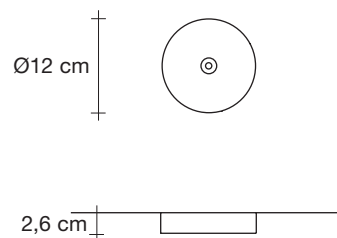

Canopy for DALI |

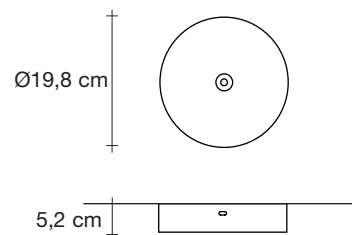

With this new suspension light, designer Dodo Arslan creates a shimmering, silver cloud. Argent consists of metal discs that have been meticulously joined by hand by Terzani craftsmen into clusters. Once lit, the multiple, angled surfaces of the discs emanate a soft, shimmering glow. Design Dodo Arslan.

Argent, a Precious, *Cloud.*

design Dodo Arslan
terzani.com

TERZANI
LA LUCE PENSATA



Type |
Wall sconce

Materials |
Stainless steel

Finishes | Code

 Stainless Steel
0N97A E7 C8

 Gold plated
0N97A L6 C8

 Rose Gold
0N97A N4 C8

or on request

 Champagne

 Black nickel

Body |

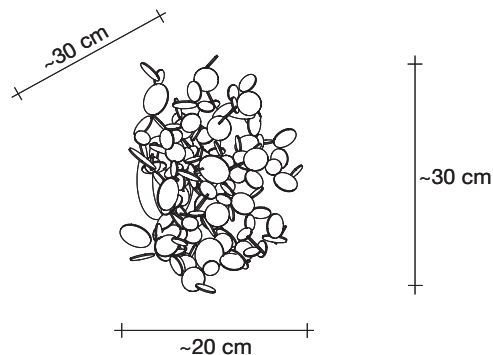

Recommended Light | Canopy |

230-240V ~ 50/60Hz

 HALOGEN
3 x 20W G4 12V

or

 LED
3 x 2W G4 12V

dimmable with

 IGBT
TRIAC
DALI system

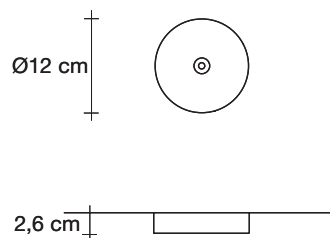

Canopy for DALI |

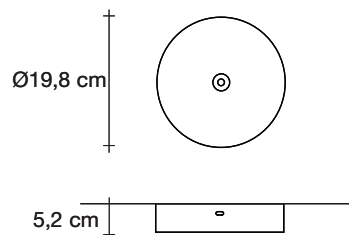

With this new suspension light, designer Dodo Arslan creates a shimmering, silver cloud. Argent consists of metal discs that have been meticulously joined by hand by Terzani craftsmen into clusters. Once lit, the multiple, angled surfaces of the discs emanate a soft, shimmering glow. Design Dodo Arslan.

Argent, a Precious, *Cloud.*

design Dodo Arslan
terzani.com

TERZANI
LA LUCE PENSATA





Type |
Wall sconce

Materials |
Stainless steel

Finishes | Code

 Stainless Steel
0N98B E7 C8

 Gold plated
0N98B L6 C8

 Rose Gold
0N98B N4 C8

or on request

 Champagne

 Black nickel

Body |

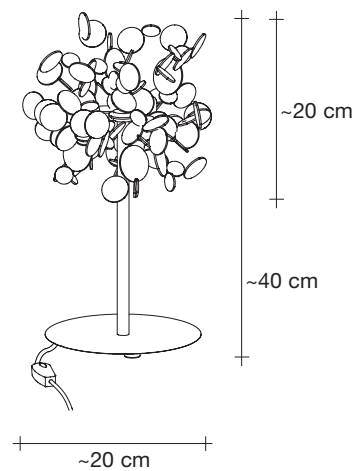

Recommended Light |

230-240V ~ 50/60Hz

 LED
3 x 2W G4 12V

dimmable with

 Not dimmable

With this new suspension light, designer Dodo Arslan creates a shimmering, silver cloud. Argent consists of metal discs that have been meticulously joined by hand by Terzani craftsmen into clusters. Once lit, the multiple, angled surfaces of the discs emanate a soft, shimmering glow. Design Dodo Arslan.