

Magdalena, cutting edge *beauty*.

design Bruno Rainaldi
terzani.com

TERZANI
LA LUCE PENSATA



Product Name



Magdalena
small pendant light

Materials

metal



Finishes | Code

-  white
OM61S E8 C8.
-  nickel
OM61S G8 C8.
-  gold leaf
OM61S H5 C8.

Body

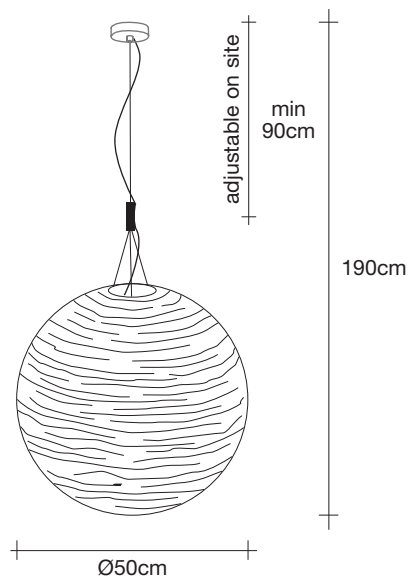

Recommended Light

230-240V ~ 50/60Hz



LED
15W E27

dimmable with



all systems

Canopy

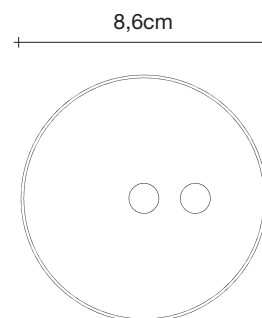

Reaching inside traditional forms, Magdalena's laser-cut, horizontal openings allow for its light to expand its range to the entire room. Creating an alluring pattern of light and shadow, Magdalena highlights the shape of the room itself. This unique exchange creates a pendant that impacts every space, regardless of size. Design Bruno Rainaldi.

Magdalena, cutting edge *beauty*.

design Bruno Rainaldi
terzani.com

TERZANI
LA LUCE PENSATA



Product Name
Magdalena
large pendant light

Materials
metal



Finishes | Code

-  white
OM62S E8 C8.
-  nickel
OM62S G8 C8.
-  gold leaf
OM62S H5 C8.

Body

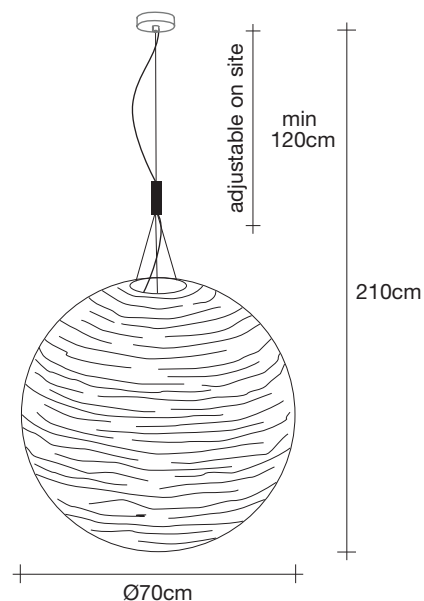

Recommended Light
230-240V ~ 50/60Hz



LED
15W E27

dimmable with



all systems

Canopy

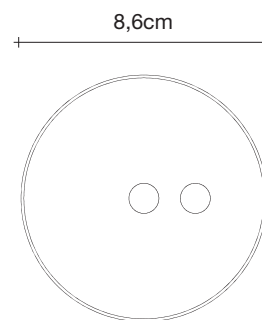

Reaching inside traditional forms, Magdalena's laser-cut, horizontal openings allow for its light to expand its range to the entire room. Creating an alluring pattern of light and shadow, Magdalena highlights the shape of the room itself. This unique exchange creates a pendant that impacts every space, regardless of size. Design Bruno Rainaldi.

Magdalena, cutting edge *beauty*.

design Bruno Rainaldi
terzani.com

TERZANI
LA LUCE PENSATA



Product Name



Magdalena
small dome pendant light

Materials

metal



Finishes | Code

-  nickel
OM65S G8 C8.
-  gold leaf
OM65S H5 C8.

Body

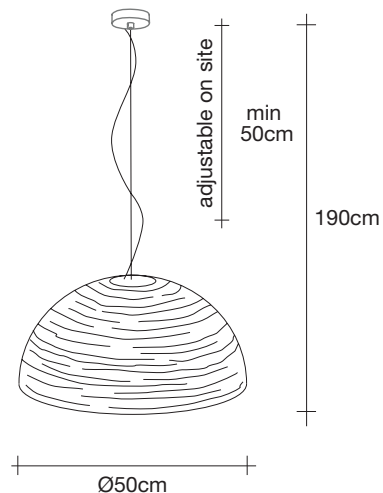

Recommended Light

230-240V ~ 50/60Hz



LED
15W E27

dimmable with



all systems

Canopy

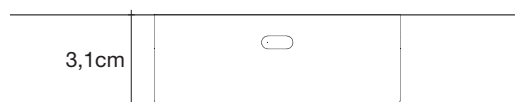
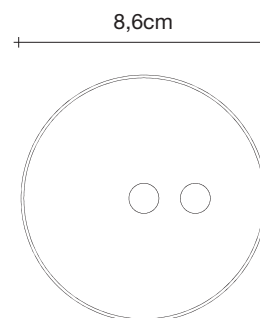

Reaching inside traditional forms, Magdalena's laser-cut, horizontal openings allow for its light to expand its range to the entire room. Creating an alluring pattern of light and shadow, Magdalena highlights the shape of the room itself. This unique exchange creates a pendant that impacts every space, regardless of size. Design Bruno Rainaldi.

Magdalena, cutting edge *beauty*.

design Bruno Rainaldi
terzani.com



Product Name
Magdalena
large dome pendant light

Materials
metal



Finishes | Code

-  white
OM66S E8 C8.
-  nickel
OM66S G8 C8.
-  gold leaf
OM66S H5 C8.

Body

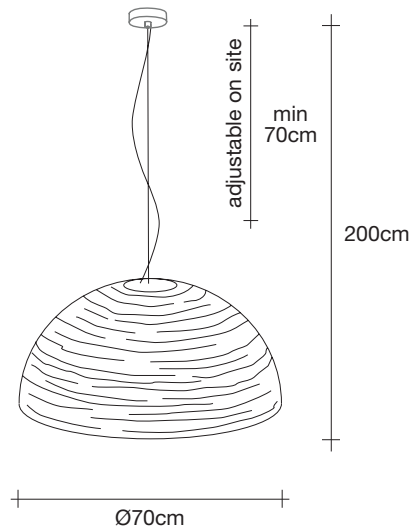

Recommended Light
230-240V ~ 50/60Hz

 LED
15W E27

dimmable with

 all systems

Canopy

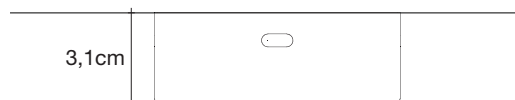
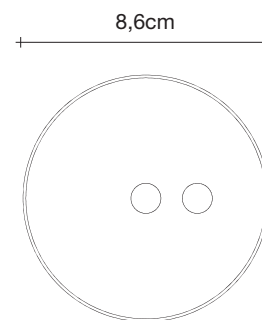

Reaching inside traditional forms, Magdalena's laser-cut, horizontal openings allow for its light to expand its range to the entire room. Creating an alluring pattern of light and shadow, Magdalena highlights the shape of the room itself. This unique exchange creates a pendant that impacts every space, regardless of size. Design Bruno Rainaldi.