

GENERAL

LOCATION:	Interior
CLASS:	CE (Class II)
IP RATING:	IP20
BATHROOM ZONE:	Zone 3
DRIVER REQUIRED:	No
INSTALLATION ORIENTATION:	Ceiling Mount - Install in to existing ceiling
MAIN MATERIAL:	Metal - Mild Steel
DIMENSIONS (mm):	H: 120 W: 175 D: 90
CUT OUT HOLE (mm/inches):	Ø: 83/3-1/4
RECESS DEPTH (mm):	150
FIRE RATING:	-
CABLE LENGTH (mm):	-
GROSS WEIGHT (kg):	0.75

LAMP

LIGHT SOURCE:	LED GU10
WATTAGE:	2 X 6W MAX
RECOMMENDED LAMP	2 X 6W MAX LED GU10
LAMP INCLUDED:	No
MAXIMUM LAMP LENGTH (mm):	57
LUMINOUS FLUX (lm):	Lamp Dependent
COLOUR TEMP (K):	Lamp Dependent
CRI (Ra):	Lamp Dependent
MACADAM ELLIPSE:	Lamp Dependent
TILT ADJUSTABLE ANGLE (°):	25
ROTATION ADJUSTABLE ANGLE (°):	360
LIFETIME (hrs):	Lamp Dependent
BEAM ANGLE (°):	Lamp Dependent

ELECTRICAL

SWITCHED:	No
DIMMABLE:	Yes
DIMMING METHOD:	Lamp Dependent
SUPPLY FREQUENCY (Hz):	-
DRIVER/BALLAST VOLTAGE (V):	-
DRIVER LIFETIME (hrs):	-
EFFICACY (lm/W):	Lamp Dependent

ADDITIONAL INFORMATION:

SHADE INCLUDED:	-
SHADE/DIFFUSER MATERIAL:	Glass
SHADE/DIFFUSER FINISH	Clear
F MARK:	Not suitable for covering with thermal insulation



CODE: 1434005
FINISH: MATT WHITE

TO MAINTAIN THIS PRODUCT TO ITS BEST CONDITION, PLEASE VIEW OUR CARE AND CLEANING GUIDE ON THE SUPPORT SECTION OF THE ASTRO WEBSITE.

Pour entretenir au mieux ce produit, veuillez consulter notre guide d'entretien et de nettoyage, dans la rubrique d'aide sur le site Web d'Astro.

Um dieses Produkt im besten Zustand zu erhalten, beachten Sie bitte unseren Leitfaden zu Pflege und Reinigung im Abschnitt „Support“ auf der Astro-Website.

Per mantenere questo prodotto nelle sue migliori condizioni, consultare la nostra guida per la manutenzione e la pulizia nella sezione dedicata all'assistenza del sito Web Astro.

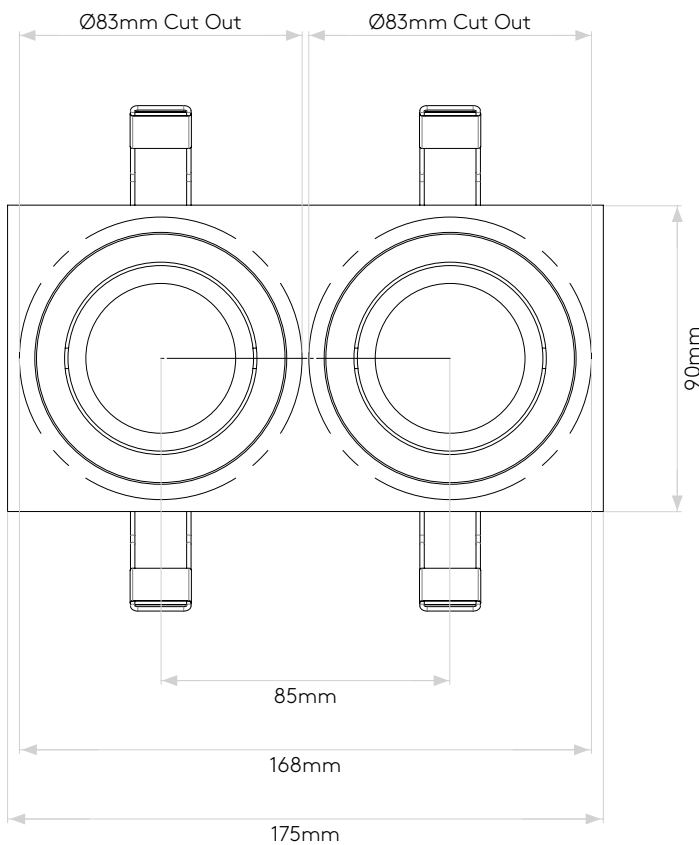
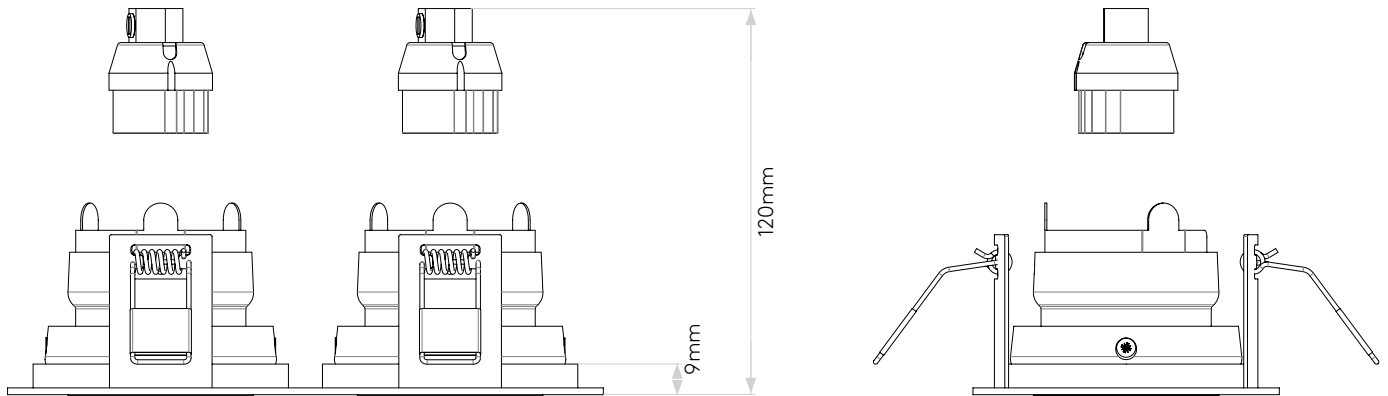

Please note that some dimensions may vary slightly due to manufacturing tolerances, this includes cable entry and fixing holes

Veuillez noter que certaines dimensions peuvent varier légèrement en raison des tolérances de fabrication, y compris l'entrée de câble et les trous de fixation.

Bitte beachten Sie, dass die Maße Fertigungstoleranzen unterliegen und daher in geringem Umfang von der angegebenen Größe abweichen können. Dies gilt auch für Kabeleingänge und Befestigungslöcher.

Si prega notare che possono esserci piccole variazioni in alcune dimensioni dovute alle tolleranze di produzione, queste includono l'ingresso del cavo e i fori di fissaggio.