

OLÁ A2 OV 70

Design by: Fly design studio

MASIERO



Lampada con struttura in metallo verniciato, pendagli in vetro Italiano verniciato.

Powder coated metal frame, coated Italian-glass pendants.

Lampe mit lackierter Metallstruktur, Gehänge aus lackiertem italienischem Glas.

Lampe avec structure en métal verni, breloques en verre italien verni.

Лампа с металлическим окрашенным каркасом, подвесы из окрашенного итальянского стекла.



H 20 cm / 7.87"
L 70 cm / 27.56"
SP 15 cm / 6.00"

TRADITIONAL LIGHTING

 2×E27×60 W max
USA 2×E26×60 W max
(not included)

LED LIGHTING

UP LED x 9.3 W CRI>80
3000 K - 1488 lm
DOWN LED x 18.6 W CRI>80
3000 K - 2976 lm
Dimmable: 1-10V + PUSH

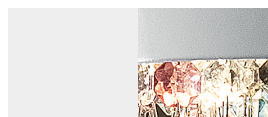
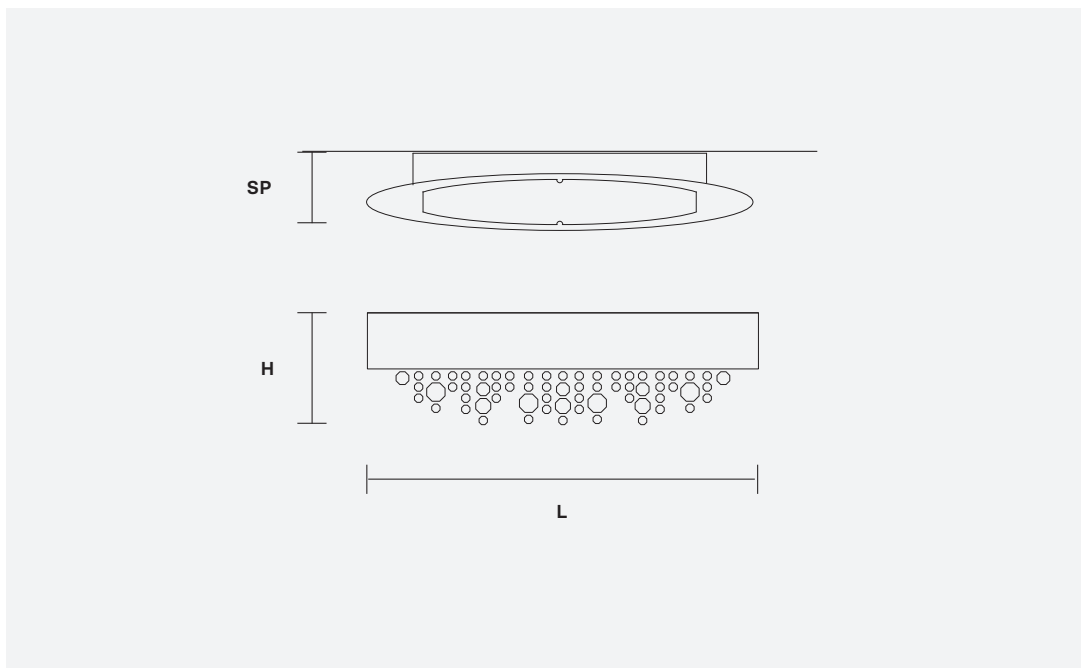

V95 Matt white frame comes with cold colours pendants (ex P06 / WH-M)



F01 Gold leaf frame comes with amber colors pendants

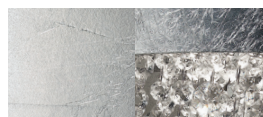

F02 Silver leaf frame comes with transparent pendants



F03 Copper leaf frame comes with copper colours pendants

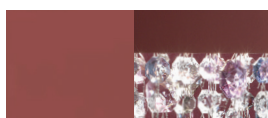

V30 Oxide red frame comes with cold colours pendants

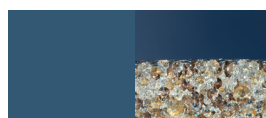

V50 Blue navy frame comes with amber colours pendants

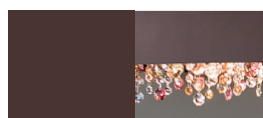

V83 Matt bronze frame comes with amber colours pendants (ex P09)



G01 Burnished frame comes with amber colours pendants