

Name: Drop S/48

Design: Christophe Mathieu / 2017

Typology: Pendant Lamp

Environment: Indoor





Technical description:

Drop is an extensive family of luminaires designed for all types of applications, from residential & hospitality applications to retail and corporate.



One of the qualities of this program is the ease of maintaining in terms of functionality and cleanliness. The glass can be cleaned with easy removal from the structure. It does not have screws. Water and non-abrasive soap can be used for cleaning. LED source change: In case one of the LEDs does not work, the lamp has an individual electronic system that allows the luminaire to continue working.

Black coaxial cable, maximum height: 13m. Cables cannot be cut, there are multiple standard measures with different heights for each collection.

Lamps description

	Grounding: compulsory
	Ready for mounting on normally flammable surface
	Dimming system 1-10 V
	134,4 W LED Leds: 48 x 2,8 W = 134,4 W Lumens: 17856 lm CRI: 90 Degrees Kelvin: 2700 ^º

Voltage: 230V~50Hz

Certifications:  

 Photometrics made according to the position the lights are shown in the catalogue and price list.

Ref	Finishings
2594821056	Dimmable 1-10V Transparent Glass
2594821057	Dimmable 1-10V Frosted Glass
2594821058	Dimmable 1-10V Green Glass
2594821059	Dimmable 1-10V Blue Glass

Dimming system 1-10 V:
Analog lighting system that allows the regulation of the light flow between 1 and 100% via an analog signal that arrives to the equipment through 2 additional control wires. These control wires have a positive and negative polarity, respectively, which must be respected at the time of wiring.

Structure finish: Ebony black

Borosilicate glass

Each light has a different cable length. The cables cannot be cut or handled.

Black coaxial cable, max. Height 13 mts.

There are 13 standard height compositions, please consult.

Custom Options:

Custom finish: desired RAL color code to be indicated.

Special measures can be done upon request.

Maximum height of the cable: 13m.



Measures

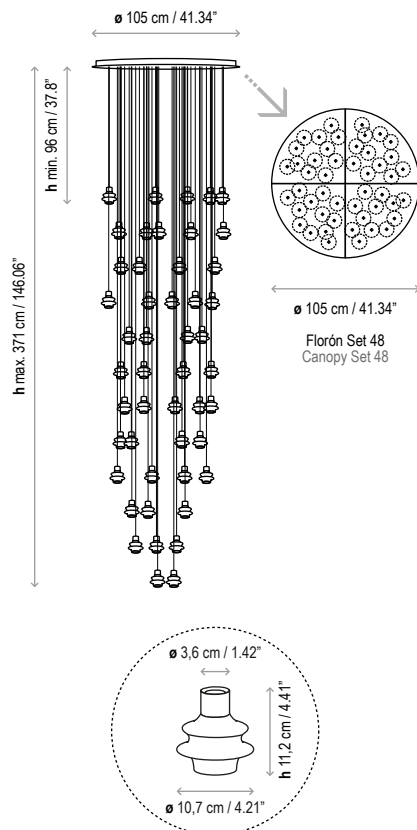

Drop S/01

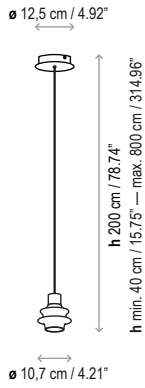

Drop S/03

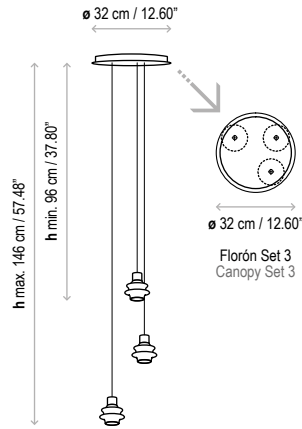

Drop S/06

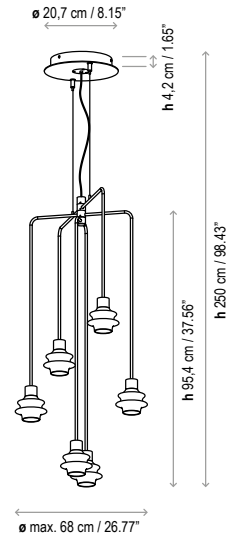

Drop S/07

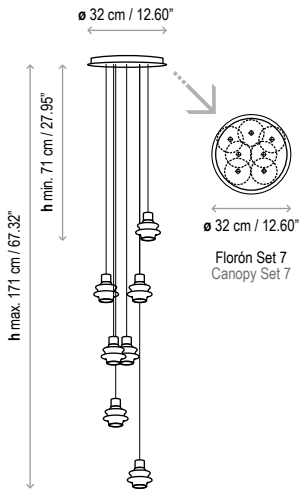

Drop S/12

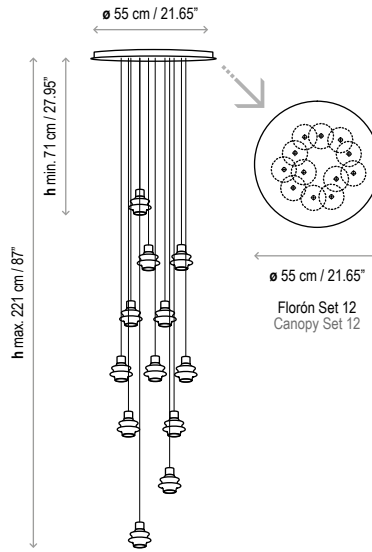

Drop S/24

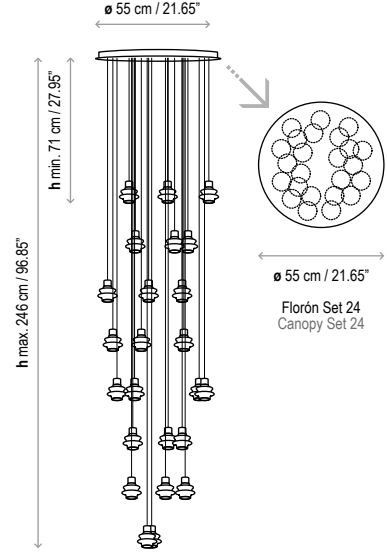

Drop S/36

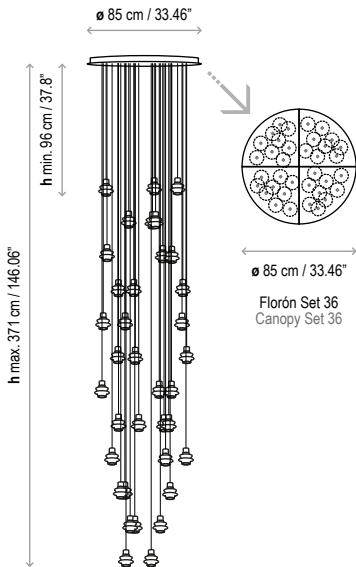

Drop S/48

