

Name: Drop S/24

Design: Christophe Mathieu / 2017

Typology: Pendant Lamp



Environment: Indoor

Technical description:

Drop is an extensive family of luminaires designed for all types of applications, from residential & hospitality applications to retail and corporate.



One of the qualities of this program is the ease of maintaining in terms of functionality and cleanliness. The glass can be cleaned with easy removal from the structure. It does not have screws. Water and non-abrasive soap can be used for cleaning. LED source change: In case one of the LEDs does not work, the lamp has an individual electronic system that allows the luminaire to continue working.



Lamps description

-  Grounding: compulsory
-  Dimming system 0-10 V
-  67.2 W LED
Leds: 24 x 2.8 W = 67.2 W
Lumens: 8928 lm
CRI: 90
Degrees Kelvin: 2700°

Voltage: 120-277 V / 50-60 Hz

2 Boxes:

-  1 Box 26.38 x 26.38 x 9.84 inches
Vol.: 3.9623 ft³ Weight: 30.20 lbs
 -  1 Box 26.38 x 26.38 x 9.84 inches
Vol.: 3.9623 ft³ Weight: 13.45 lbs
- Net weight: 29.76 lbs

Certifications:  

 Photometrics made according to the position the lights are shown in the catalogue and price list.

Black coaxial cable, maximum height: 13m. Cables cannot be cut, there are multiple standard measures with different heights for each collection.

Ref	Finishings
2592421056U	Dimmable 0-10V Transparent Glass
2592421057U	Dimmable 0-10V Frosted Glass
2592421058U	Dimmable 0-10V Green Glass
2592421059U	Dimmable 0-10V Blue Glass

Dimming system 0-10 V:
Analog lighting system that allows the regulation of the light flow between 0 and 100% via an analog signal that arrives to the equipment through 2 additional control wires. These control wires have a positive and negative polarity, respectively, which must be respected at the time of wiring.

Structure finish: Ebony black

Borosilicate glass

Each light has a different cable length. The cables cannot be cut or handled.

Black coaxial cable, max. Height 13 mts.

There are 13 standard height compositions, please consult.

Custom Options:

Custom finish: desired RAL color code to be indicated.

Special measures can be done upon request.

Maximum height of the cable: 13m.



Measures

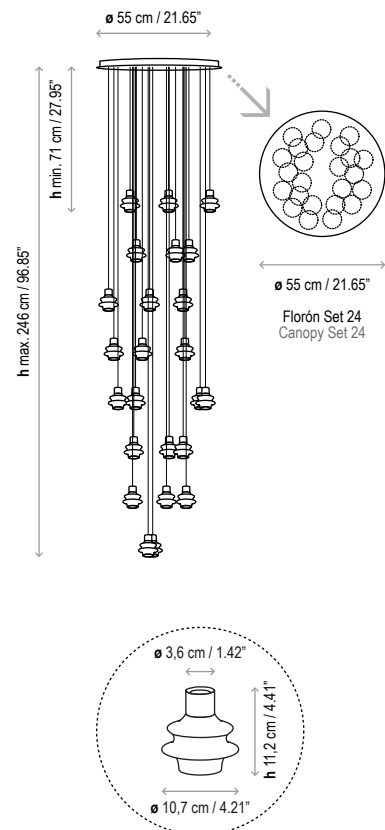

Drop S/01

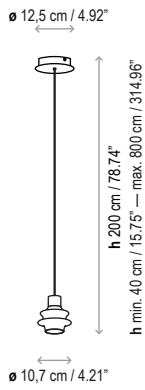

Drop S/03

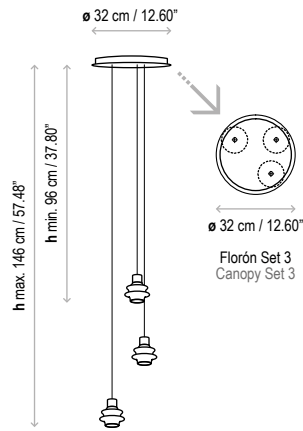

Drop S/06

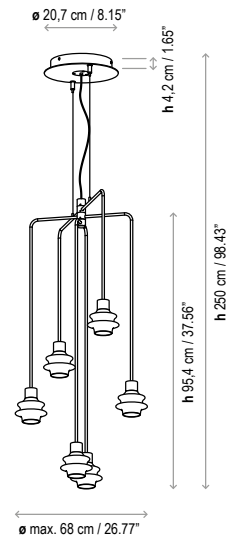

Drop S/07

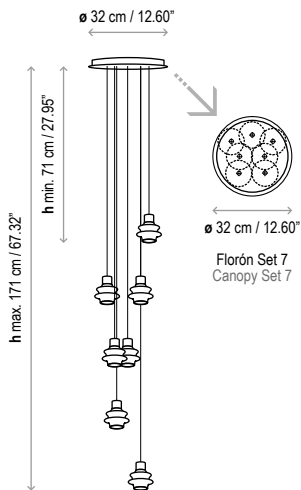

Drop S/12

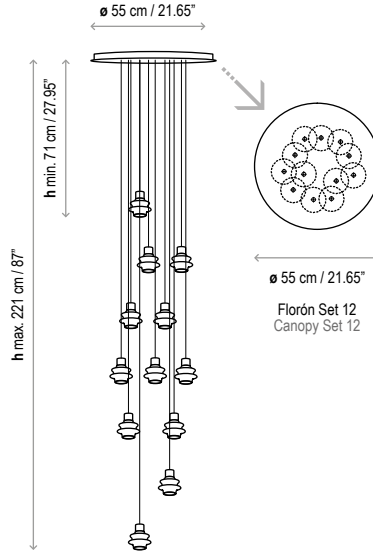

Drop S/24

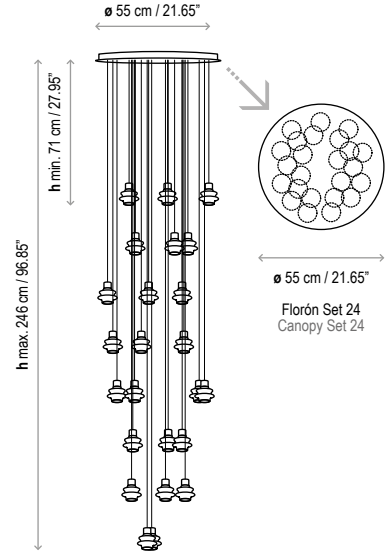

Drop S/36

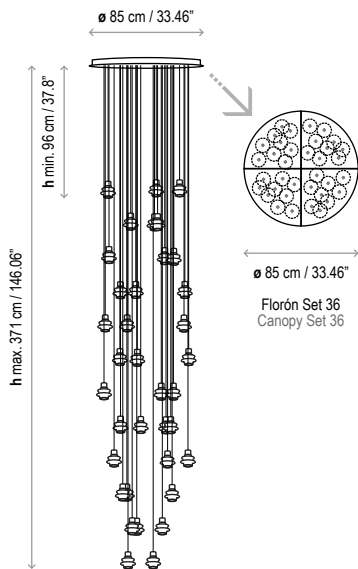

Drop S/48

