

Name: Drip S/12

Design: Christophe Mathieu / 2017

Typology: Pendant Lamp

Environment: Indoor

Technical description:

Drip is an extensive family of luminaires designed for all types of applications, from residential & hospitality applications to retail and corporate.

One of the qualities of this program is the ease of maintaining in terms of functionality and cleanliness. The glass can be cleaned with easy removal from the structure. It does not have screws. Water and non-abrasive soap can be used for cleaning. LED source change: In case one of the LEDs does not work, the lamp has an individual electronic system that allows the luminaire to continue working.

Lamps description

 Grounding: compulsory

 TRIAC dimming system

 33.6 W LED
Leds: 12 x 2.8 W = 33.6 W
Lumens: 4464 lm
CRI: 90
Degrees Kelvin: 2700°



Voltage: 120-277 V / 50-60 Hz

2 Boxes:

 1 Box 21.65 x 22.05 x 9.45 inches
Vol.: 2.6098 ft³ Weight: 25.35 lbs

 1 Box 18.50 x 18.50 x 14.57 inches
Vol.: 2.8852 ft³ Weight: 8.16 lbs

Net weight: 24.25 lbs

Certifications:  

 Photometrics made according to the position the lights are shown in the catalogue and price list.

Black coaxial cable, maximum height: 13m. Cables cannot be cut, there are multiple standard measures with different heights for each collection.

Ref	Finishings
2591221538U	Dimmable Triac Transparent Glass
2591221539U	Dimmable Triac Frosted Glass
2591221581U	Dimmable Triac Green Glass
2591221586U	Dimmable Triac Blue Glass

TRIAC dimming system:
Triac is a 3 terminal semiconductor electronic switch, it is used to control the alternating current AC.

Structure finish: Ebony black

Borosilicate glass

Each light has a different cable length. The cables cannot be cut or handled.

Black coaxial cable, max. Height 13 mts.

There are 13 standard height compositions, please consult.

Custom Options:

Custom finish: desired RAL color code to be indicated.

Special measures can be done upon request.

Maximum height of the cable: 13m.

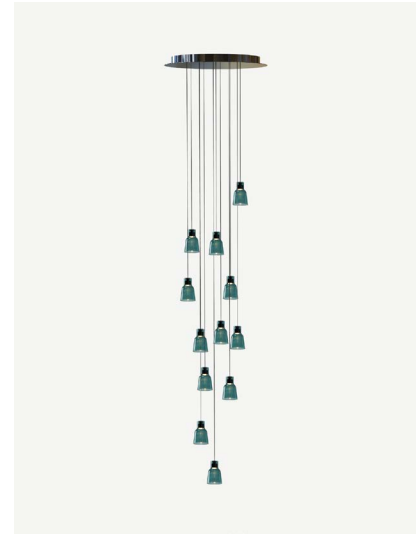

Measures

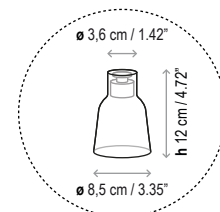
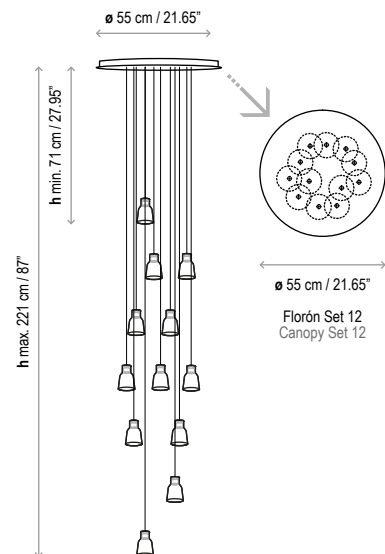

Drip S/01

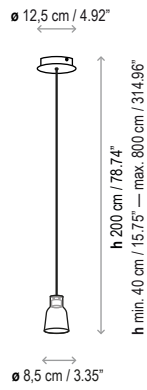

Drip S/03

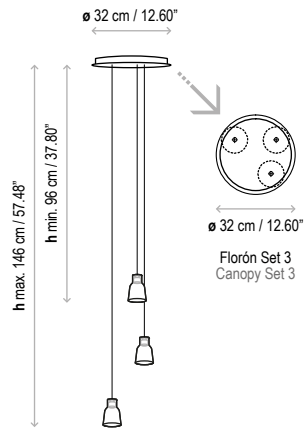

Drip S/06

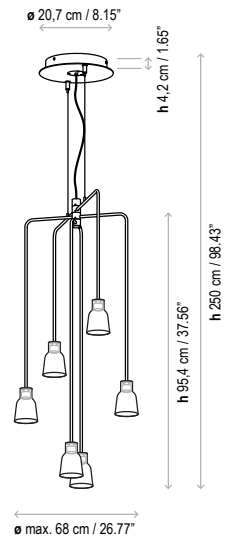

Drip S/07

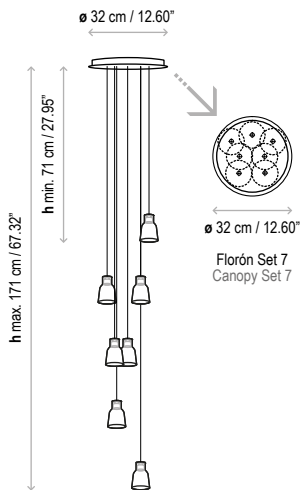

Drip S/12

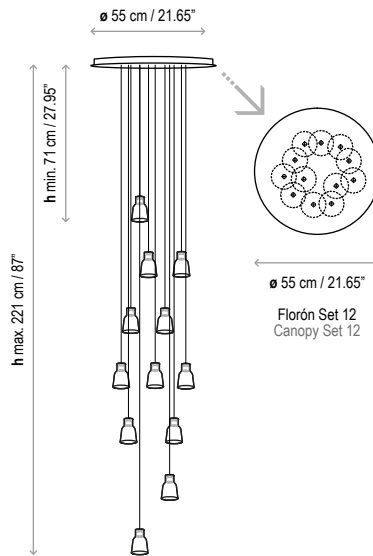

Drip S/24

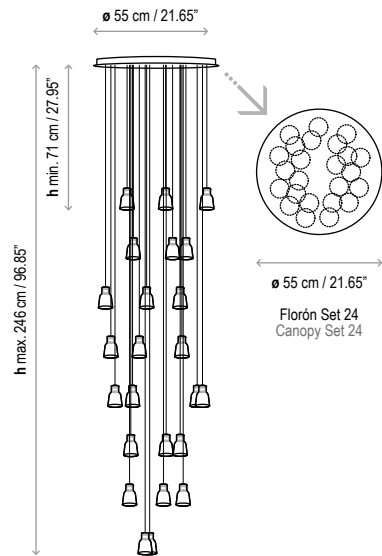

Drip S/36

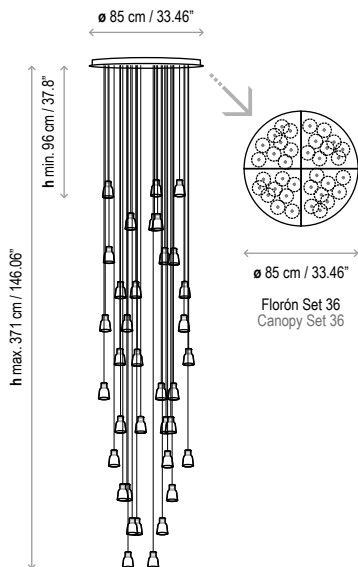

Drip S/48

