

Name: Drip S/07

Design: Christophe Mathieu / 2017

Typology: Pendant Lamp









Environment: Indoor

Technical description:

Drip is an extensive family of luminaires designed for all types of applications, from residential & hospitality applications to retail and corporate.

One of the qualities of this program is the ease of maintaining in terms of functionality and cleanliness. The glass can be cleaned with easy removal from the structure. It does not have screws. Water and non-abrasive soap can be used for cleaning. LED source change: In case one of the LEDs does not work, the lamp has an individual electronic system that allows the luminaire to continue working.

Lamps description

	Grounding: compulsory
	Ready for mounting on normally flammable surface
	TRIAC dimming system
	19,6 W LED Leds: 7 x 2,8 W = 19,6 W Lumens: 2604 lm CRI: 90 Degrees Kelvin: 2700 ^º
Voltage: 230V~50Hz	
	1 Box 61 x 40 x 61 cm
Vol.: 0,1488 m ³	
Weight: 9 kg / Net weight: 4,85 kg	
Certifications:  	
	Photometrics made according to the position the lights are shown in the catalogue and price list.

Black coaxial cable, maximum height: 13m. Cables cannot be cut, there are multiple standard measures with different heights for each collection.



Ref	Finishings
2590721538	Dimmable Triac Transparent Glass
2590721539	Dimmable Triac Frosted Glass
2590721581	Dimmable Triac Green Glass
2590721586	Dimmable Triac Blue Glass

TRIAC dimming system:
Triac is a 3 terminal semiconductor electronic switch, it is used to control the alternating current AC.

Structure finish: Ebony black

Borosilicate glass

Each light has a different cable length. The cables cannot be cut or handled.

Black coaxial cable, max. Height 13 mts.

There are 13 standard height compositions, please consult.

Custom Options:

Custom finish: desired RAL color code to be indicated.

Special measures can be done upon request.

Maximum height of the cable: 13m.

Measures

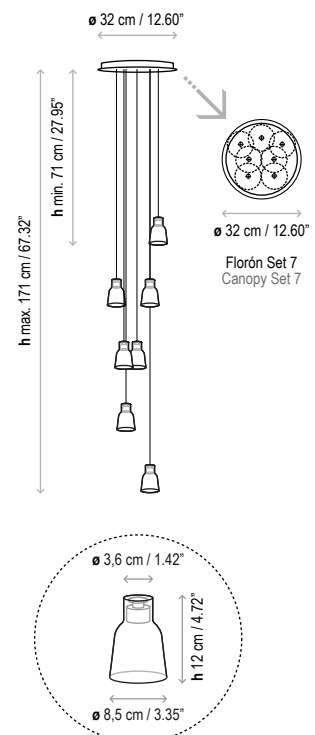

Drip S/01

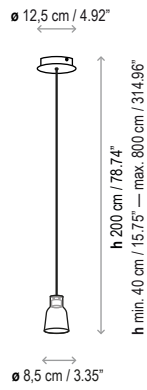

Drip S/03

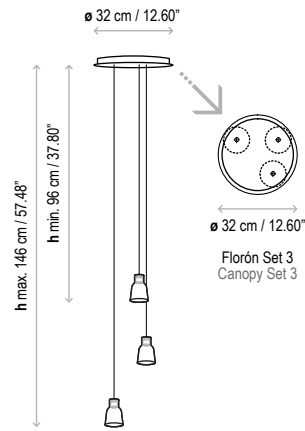

Drip S/06

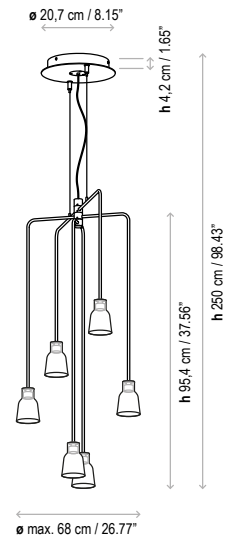

Drip S/07

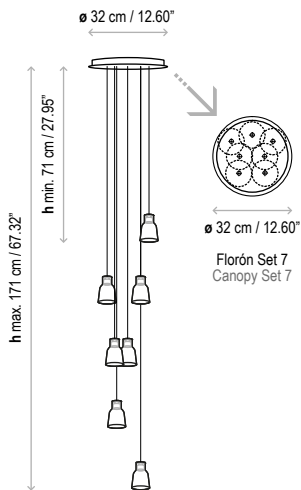

Drip S/12

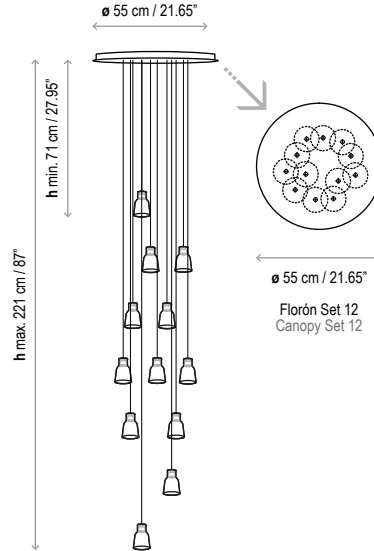

Drip S/24

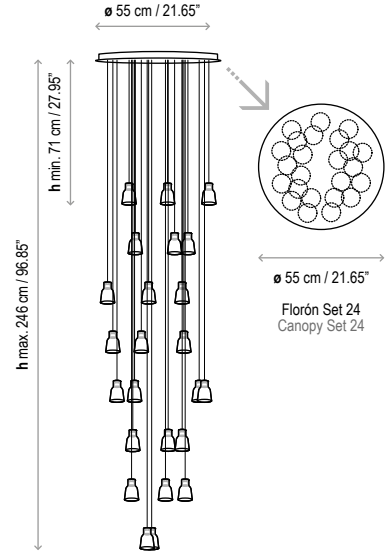

Drip S/36

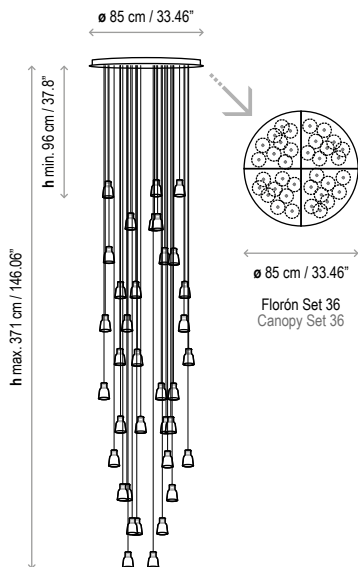

Drip S/48

