

Name: Drip S/07

Design: Christophe Mathieu / 2017

Typology: Pendant Lamp

Environment: Indoor

Technical description:

Drip is an extensive family of luminaires designed for all types of applications, from residential & hospitality applications to retail and corporate.

One of the qualities of this program is the ease of maintaining in terms of functionality and cleanliness. The glass can be cleaned with easy removal from the structure. It does not have screws. Water and non-abrasive soap can be used for cleaning. LED source change: In case one of the LEDs does not work, the lamp has an individual electronic system that allows the luminaire to continue working.

Black coaxial cable, maximum height: 13m. Cables cannot be cut, there are multiple standard measures with different heights for each collection.



Lamps description

 Grounding: compulsory

 TRIAC dimming system



 19.6 W LED
Leds: 7 x 2.8 W = 19.6 W
Lumens: 2604 lm
CRI: 90
Degrees Kelvin: 2700°

Voltage: 120-277 V / 50-60 Hz

 1 Box 24.02 x 15.75 x 24.02 inches

Vol.: 5.2548 ft³

Weight: 19.84 lbs / Net weight: 10.69 lbs

Certifications:  

 Photometrics made according to the position the lights are shown in the catalogue and price list.

Ref	Finishings
2590721538U	Dimmable Triac Transparent Glass
2590721539U	Dimmable Triac Frosted Glass
2590721581U	Dimmable Triac Green Glass
2590721586U	Dimmable Triac Blue Glass

TRIAC dimming system:
Triac is a 3 terminal semiconductor electronic switch, it is used to control the alternating current AC.

Structure finish: Ebony black

Borosilicate glass

Each light has a different cable length. The cables cannot be cut or handled.

Black coaxial cable, max. Height 13 mts.

There are 13 standard height compositions, please consult.

Custom Options:

Custom finish: desired RAL color code to be indicated.

Special measures can be done upon request.

Maximum height of the cable: 13m.

Measures

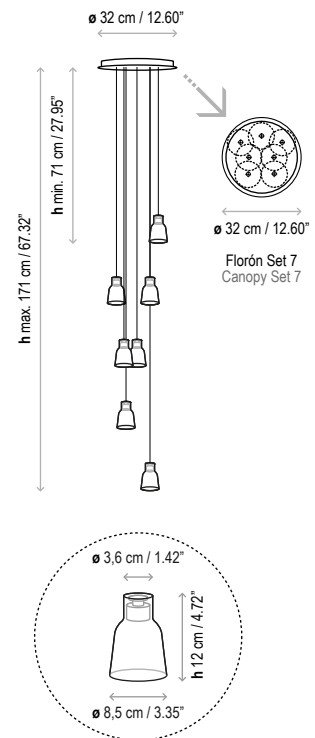

Drip S/01

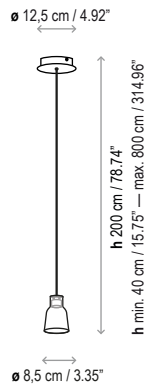

Drip S/03

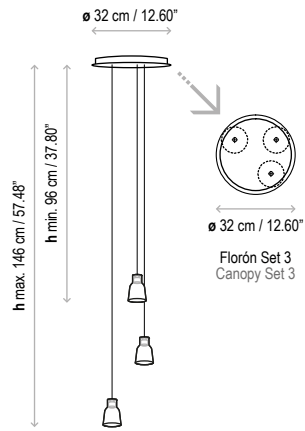

Drip S/06

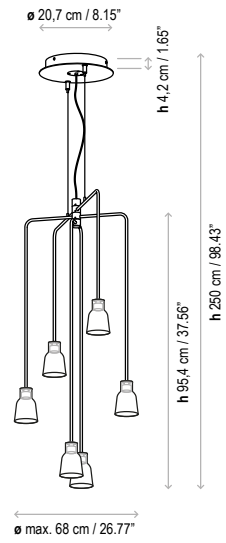

Drip S/07

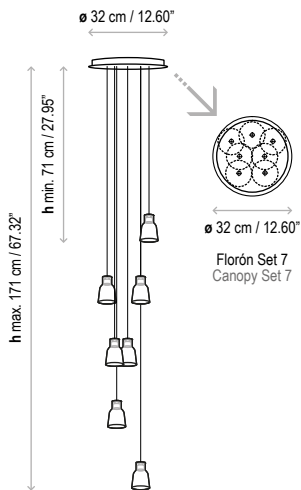

Drip S/12

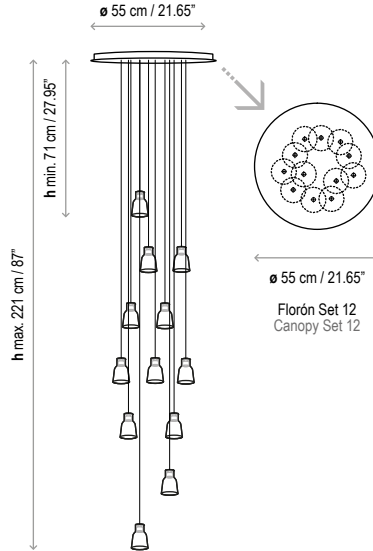

Drip S/24

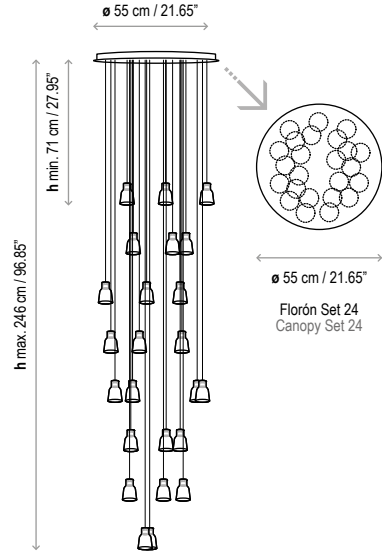

Drip S/36

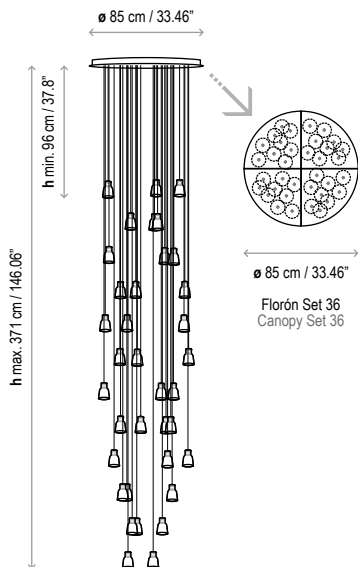

Drip S/48

