

Name: Drop S/01

Design: Christophe Mathieu / 2017

Typology: Pendant Lamp

Environment: Indoor

Technical description:

Drop is an extensive family of luminaires designed for all types of applications, from residential & hospitality applications to retail and corporate.



One of the qualities of this program is the ease of maintaining in terms of functionality and cleanliness. The glass can be cleaned with easy removal from the structure. It does not have screws. Water and non-abrasive soap can be used for cleaning.

Black coaxial cable, maximum height: 13m.

Cables cannot be cut, there are multiple standard measures with different heights for each collection.



Lamps description

-  Grounding: compulsory
-  3 W LED
Lumens: 345 lm
CRI: 90
Degrees Kelvin: 2700°



Not Dimmable

Voltage: 120V~60Hz

 1 Box 8.66 x 9.45 x 8.66 inches

Vol.: 0.4097 ft³

Weight: 2.54 lbs / Net weight: 2.09 lbs

Certifications:  

 Photometrics made according to the position the lights are shown in the catalogue and price list.

Ref Finishings

2590120856U Transparent Glass

2590120857U Frosted Glass

2590120858U Green Glass

2590120859U Blue Glass

Structure finish: Ebony black

Borosilicate glass

Black coaxial cable

Custom Options:

Custom finish: desired RAL color code to be indicated.

Special measures can be done upon request.

Maximum height of the cable: 13m.

Measures

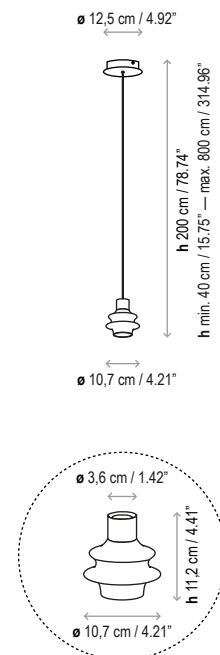

Drop S/01

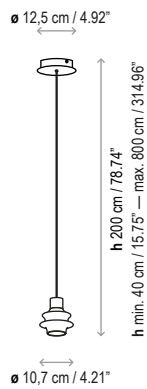

Drop S/03

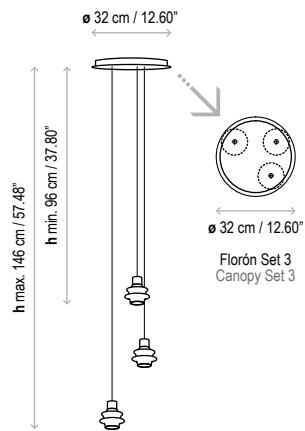

Drop S/06

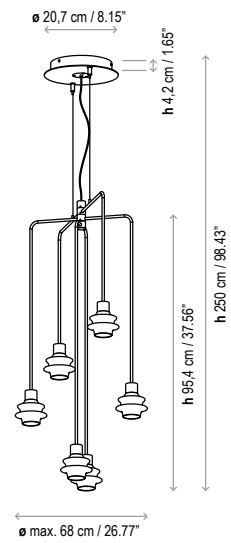

Drop S/07

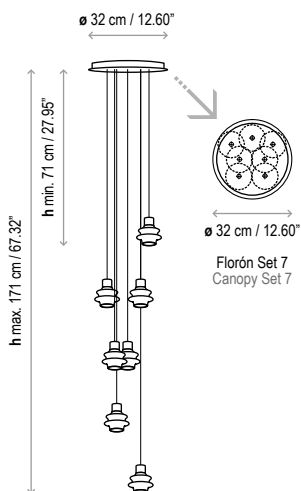

Drop S/12

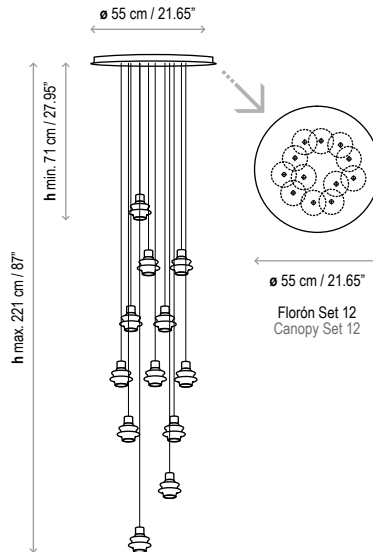

Drop S/24

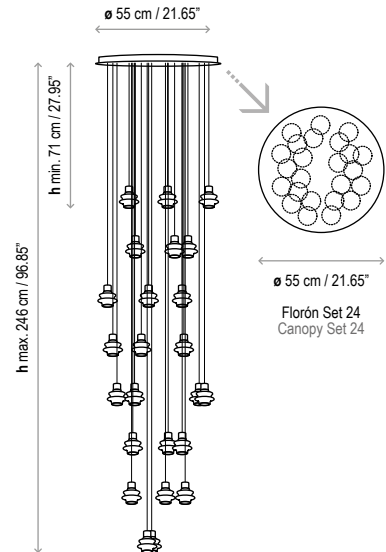

Drop S/36

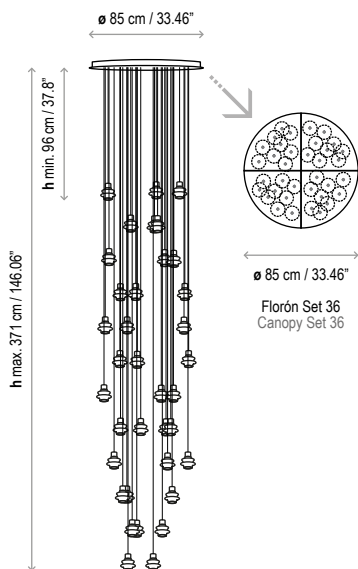

Drop S/48

