

Name: Drip S/01

Design: Christophe Mathieu / 2017

Typology: Pendant Lamp

Environment: Indoor

Technical description:

Drip is an extensive family of luminaires designed for all types of applications, from residential & hospitality applications to retail and corporate.





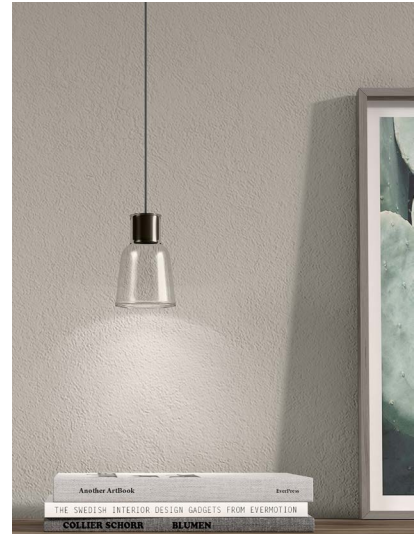

One of the qualities of this program is the ease of maintaining in terms of functionality and cleanliness. The glass can be cleaned with easy removal from the structure. It does not have screws. Water and non-abrasive soap can be used for cleaning.

Black coaxial cable, maximum height: 13m.

Cables cannot be cut, there are multiple standard measures with different heights for each collection.



Lamps description

	Grounding: compulsory
	3 W LED Lumens: 345 lm CRI: 90 Degrees Kelvin: 2700°
	Not Dimmable
	Voltage: 120V~60Hz
	1 Box 8.66 x 9.45 x 8.66 inches
	Vol.: 0.4097 ft ³
	Weight: 2.54 lbs / Net weight: 2.09 lbs
	Certifications:  
	Photometrics made according to the position the lights are shown in the catalogue and price list.

Ref	Finishings
2590120838U	Transparent Glass
2590120839U	Frosted Glass
2590120881U	Green Glass
2590120886U	Blue Glass
Structure finish: Ebony black	
Borosilicate glass	
Black coaxial cable	
Custom Options:	
Custom finish: desired RAL color code to be indicated.	
Special measures can be done upon request.	
Maximum height of the cable: 13m.	

Measures

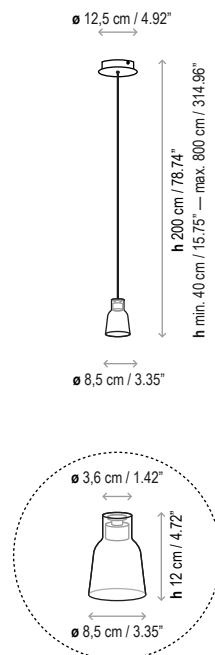

Drip S/01

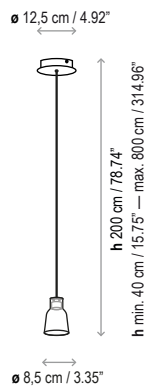

Drip S/03

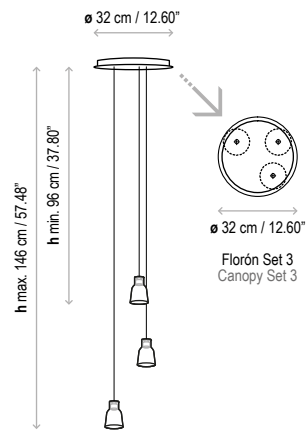

Drip S/06

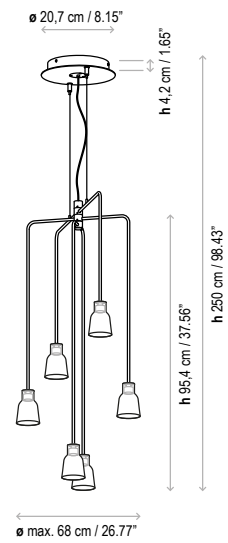

Drip S/07

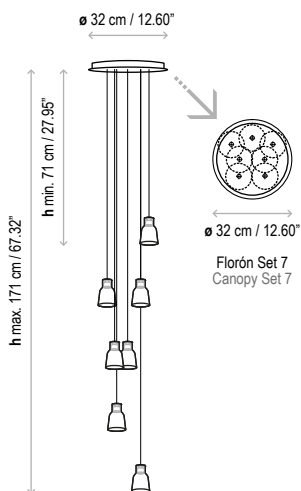

Drip S/12

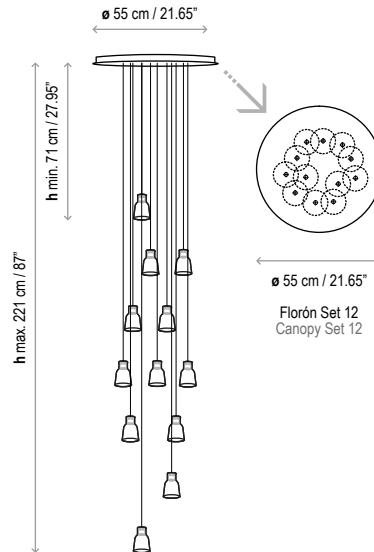

Drip S/24

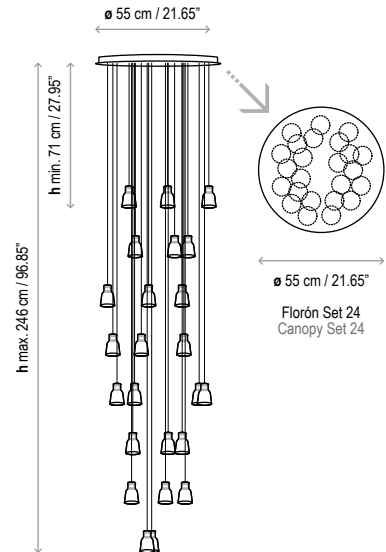

Drip S/36

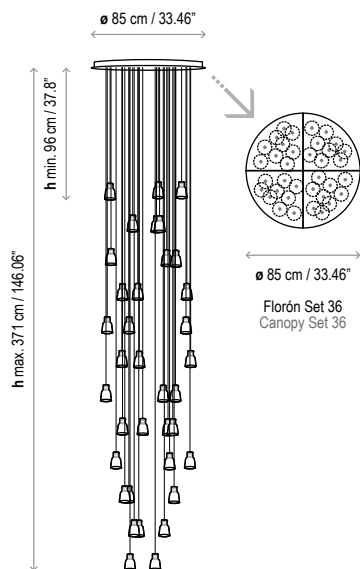

Drip S/48

