

Name: Tibeta - Set 3

Design: Christophe Mathieu / 2015

Typology: Pendant lamp









Environment: Indoor

Technical description:

3 pendant linear fixture. Each pendant is made of spun aluminum available in black chrome with black fabric cable, brilliant copper with copper metal mesh cable and antique brass with black fabric cable. Each pendant houses an LED plate diffused through opal glass. Dimming system: TRIAC.



Lamps description

-  Grounding: compulsory
-  Ready for mounting on normally flammable surface
-  TRIAC dimming system
-  30,4 W LED
Led: 30,4 W LED
Lumens: 2155 lm
CRI: 80
Degrees Kelvin: 2900^º-3200^º
- Voltage: 230V~50Hz
-  1 Box 47 x 40 x 106 cm
- Vol.: 0,1993 m³ Weight: 17 kg
- Certifications:  
-  Photometrics made according to the position the lights are shown in the catalogue and price list.

Ref Finishings

2570420107	Black Chrome Black Fabric Cable Black Canopy
2570420190	Brilliant Copper Copper Metal Mesh White Canopy
2570420179	Antique Brass Black Fabric Cable Black Canopy
TRIAC Dimmable	
Not Customizable	

Measures

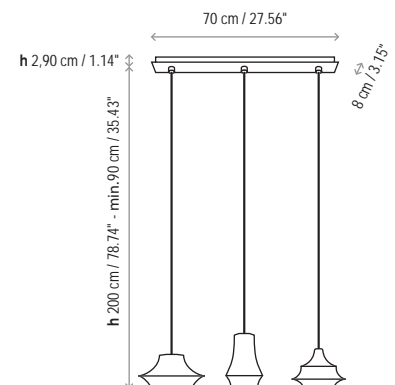

Tibeta - 01

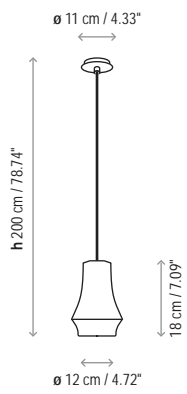

Tibeta - 02

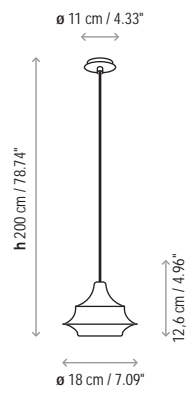

Tibeta - 03

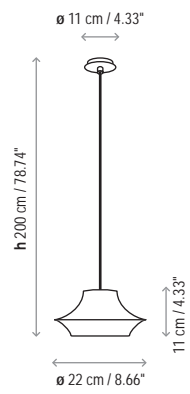

Tibeta - Set 3

